

2021

€ **FİYAT LİSTESİ**

5 / Basınç Ölçerler

31 / Basınç Aksesuarları

33 / Sıcaklık Ölçerler

Fiyatlarımıza K.D.V. dahil değildir.

Ödeme vadesi 60 (altmış) gündür.

Bu fiyat listesi en güncel bilgileri sunmaktadır.

PAKKENS mamullerin ve fiyatların üzerinde önceden bildirmeden her türlü değişiklik yapma hakkını saklı tutar.

İÇİNDEKİLER

2	Hakkımızda
3	Basınç Ölçer Seçimi
5	Basınç Ölçerler
6	MG Serisi Genel Amaçlı Basınç Ölçerler
9	MG Serisi Genel Amaçlı, Gliserin Dolgulu Basınç Ölçerler
11	MH Serisi Hassas Basınç Ölçerler
12	MH Serisi Hassas, Sıvı Dolgulu Basınç Ölçerler
13	MH Serisi Hassas, Komple Paslanmaz Basınç Ölçerler
14	MH Serisi Hassas, Komple Paslanmaz, Sıvı Dolgulu Basınç Ölçerler
15	MH Serisi Hassas, Solid Front Basınç Ölçerler
16	MK Serisi Kontaklı, Hassas Basınç Ölçerler
16	MK Serisi Kontaklı, Silikon Dolgulu, Hassas Basınç Ölçerler
17	MK Serisi Kontaklı, Komple Paslanmaz, Hassas Basınç Ölçerler
17	MK Serisi Kontaklı, Komple Paslanmaz, Silikon Dolgulu, Hassas Basınç Ölçerler
18	MT Serisi Basınç Sensörleri (Manotransmitterler, Transmitterler)
19	MC Serisi Kapsül Diyaframlı Basınç Ölçerler
20	MC Serisi Kapsül Diyaframlı, Sıvı Dolgulu Basınç Ölçerler
21	MC Serisi Kapsül Diyaframlı, Komple Paslanmaz Basınç Ölçerler
21	MC Serisi Kapsül Diyaframlı, Komple Paslanmaz, Sıvı Dolgulu Basınç Ölçerler
22	DG Serisi Fark Basınç Ölçerler
23	U Manometre
24	DS Serisi Diyafram Ayırıcılı Hassas Basınç Ölçerler
27	SH Serisi Schaeffer Tip Hassas Basınç Ölçerler
28	MH Serisi Master Basınç Ölçerler
28	Kalibrasyon Hizmetleri
29	Manifoldlar
31	Basınç Aksesuarları
33	Sıcaklık Ölçerler
34	TE Serisi Bi-metal Sıcaklık Ölçerler
35	TB Serisi Komple Paslanmaz Bi-Metal Sıcaklık Ölçerler
36	TB Serisi Komple Paslanmaz Sızdırmaz Tip Bi-Metal Sıcaklık Ölçerler
37	TB Serisi Komple Paslanmaz Sıvı Dolgulu Bi-Metal Sıcaklık Ölçerler
38	TG Serisi Komple Paslanmaz Gazlı Sıcaklık Ölçerler
39	TG Serisi Komple Paslanmaz Gazlı Hassas Sıcaklık Ölçerler
40	TK Serisi Kontaklı, Gazlı Sıcaklık Ölçerler
41	TK Serisi Komple Paslanmaz, Kontaklı, Gazlı, Hassas Sıcaklık Ölçerler
42	TI Serisi Gazlı, Genel Amaçlı Sıcaklık Ölçerler
43	TI Serisi Kombine Ölçerler
44	Termoviller

Hakkımızda

PAKKENS, 45 yılı aşkın bir süredir her türlü basınç ve sıcaklık ölçüm cihazlarının, HVAC ve tesisat ürünlerinin, ısıtma sektörü için hidrolik grupların ve müşteriye özel hassas talaşlı imalat parçalarının tasarım ve üretimini gerçekleştiren, alanının lider firmasıdır.

Firma, Bursa Organize Sanayi Bölgesindeki tam entegre iki üretim tesisinde toplam 450 nin üzerinde yetkin personeli ile petro-kimya, gaz dağıtımı, ilaç, biyoteknoloji, gıda işleme, HVAC, makine imalatı, hidrolik, tarım, inşaat, otomotiv, savunma ve havacılık vb. sektörlerdeki ana sanayi firmaları ve son kullanıcılara hizmet vermektedir.

Ölçüm cihazları portföyü, standart ve yüksek hassasiyetli endüstriyel basınç ölçerler, kontaklı tip basınç ölçerler, çıkış sinyalli basınç ölçerler, diferansiyel basınç ölçerler, diyafram ayırıcılı basınç ölçerler, kapsül diyaframlı basınç ölçerler, emniyet plakalı basınç ölçerler, basınç transmitterleri, bi-metal ve gazlı tip termometreler, kombine ölçerler, valf ve manifoldlar, termoviller, enstrümantasyon aksesuarları ve kalibrasyon hizmetlerinden oluşur.

PAKKENS®

- ✓ Ölçüm cihazları alanında Türkiye'de pazar lideridir.
- ✓ Türkiye'nin ilk ve en gelişmiş basınç ölçer kalibrasyon laboratuvarına sahiptir.
- ✓ Portföyünde 15.000 adedin üzerinde standart ve müşteriye özel ürün bulundurmaktadır.
- ✓ Sınıfının en iyisi ürünleri en makul fiyat seviyelerinde üretmek için gerekli, çok iyi yapılmış tasarım, üretim, kalite, planlama ve lojistik süreçlerine sahiptir.
- ✓ Ürünlerini gerçekleştirmek için en gelişmiş üretim ve test teknolojilerini kullanmaktadır.
- ✓ Konsept tasarımdan seri üretime kadar tüm süreçleri bünyesinde barındıran tam entegre bir şirkettir.
- ✓ ISO 9001:2015, ISO 14001:2015, OHSAS 18001:20017 ve AS9100 Rev.D kalite sistem sertifikalarına ve ürünlerinin yurtdışı pazarlarda satışı için gerekli tüm ürün sertifikasyonlarına sahiptir.

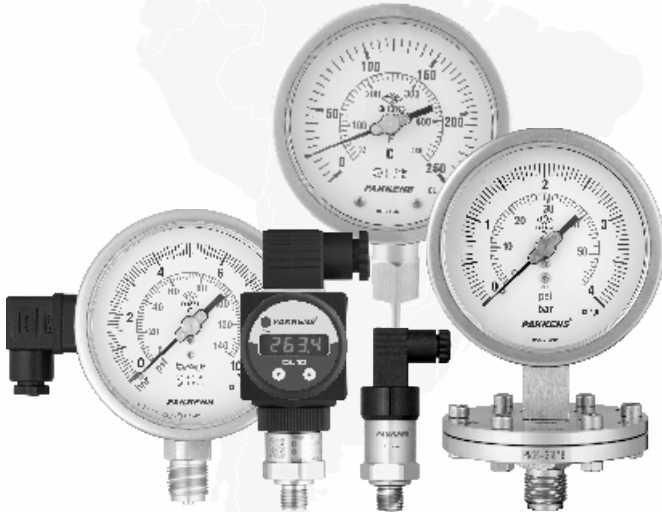



Basınç Ölçer Seçimi

İhtiyacınıza en uygun basınç ölçerin seçiminde aşağıdaki hususları dikkate almanız önerilir:



Basınç ölçümü yapılacak akışkanın bileşimi

Basınç ölçerinizin duyar elemanı doğrudan ölçüm yapılacak akışkanın içinde yer alabileceği için, akışkanın özellikleri önemlidir. Akışkanlar aşındırıcı ya da kolay kristalleşebilen özellikte olabilirler ya da ölçüm elemanı üzerinde kalıntı bırakabilirler. Normal koşullar altında kristalleşmeyecek ya da kalıntı bırakmayacak sıvılar söz konusu olduğunda, Bourdon tüplü bir basınç ölçer kullanılabilir. Diğer koşullarda ise diyafram ayırıcılı ürünler tercih edilmelidir.

Basınç ölçümü yapılacak akışkanın sıcaklığı

Buhar ya da yüksek sıcaklıktaki diğer akışkanlar, cihaz bileşenlerinin sıcaklıklarını sızdırmazlık elemanları için güvenli kabul edilen düzeylerin üzerine çıkarabilir. Bunun gibi durumlarda, basınç ölçer ile birlikte bir sifon, soğutma kulesi ya da diyafram kullanılması önerilir.

Çevre koşulları

Ölçüm cihazı seçimi sırasında, nem ve iklim koşullarının etkileri de göz önünde bulundurulmalıdır. Çok yüksek ortam sıcaklıklarından kaynaklanabilecek ölçüm hataları, ölçüm cihazının bir diyafram ayırıcı ve kapiler boru kullanılarak ısı kaynağından uzağa monte edilmesi ile engellenebilir.

Basınç aralığı

EN837-2'ye göre manometre kullanılması planlanan bir sistemin maksimum kararlı çalışma basıncı, manometrenin tam skala değerinin %75'i olmalıdır.

Ancak, basınç dalgalanması olan bir sistemin maksimum çalışma basıncı, manometrenin tam skala değerinin %65'i olmalıdır.

Bunun yanı sıra tahdit pimli manometrelerin tam skalasının %10 ile %75'i arasında doğru ölçüm aralığına sahip olduğu, tahdit pimsiz manometrelerin ise tam skalalarında doğru ölçümler için kullanılabileceği unutulmamalıdır.



Sistemin aşınmasını etkileyen koşullar

Şiddetli basınç dalgalanmaları ya da yoğun titreşim içeren uygulamalarda, basınç sınırlayıcı ya da düşürücü aksesuarlar kullanılması önerilir. Sıvı dolgulu basınç ölçerler de yine bu tip koşullarda daha uzun ömürlü olacaklardır. **PAKKENS** sıvı dolgulu basınç ölçerleri genellikle gliserin ile doldurulurlar. Ürün gamında daha geniş bir sıcaklık aralığında çalışma gereksinimi için silikon dolgulu basınç ölçerler de bulunmaktadır.



Bağlantı yöntemi

Birçok **PAKKENS** ölçüm cihazının Alttan ya da Arkadan bağlantılı versiyonları mevcuttur. Standart olarak sunulan dış tipleri dışında, **PAKKENS** birçok ürünü için farklı dış tipi/ölçüsü seçenekleri sunmaktadır.

Basınç ölçerlerin normal şartlarda her zaman dik olarak bağlanması gerektiği unutulmamalıdır. Bağlantının yatay veya baş aşağı olarak yapılmasının zorunlu olduğu durumlarda, satış bölümümüz ile görüşülmesi önerilir.



Hassasiyet sınıfı

PAKKENS, %+-0,25 den %+-2,5 a kadar farklı hassasiyet sınıflarında basınç ölçerler üretmektedir. Uygulamanız için en iyi sonucu almanız, doğru hassasiyete sahip bir cihaz seçimi ile mümkün olabilir.

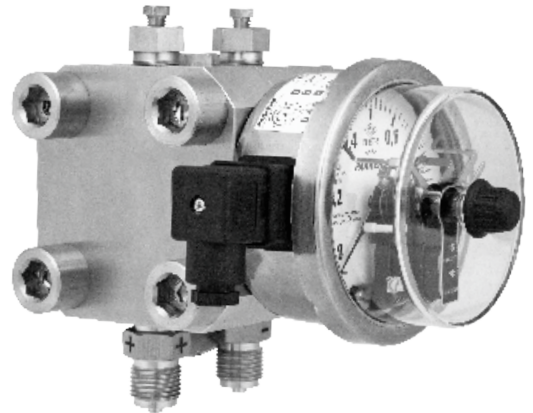

Yukarıda bahsedilen cihaz seçim faktörleri, ölçüm cihazınızın güvenli bir şekilde ve ihtiyaç duyulan doğrulukta çalışabilmesi için önemlidir. Cihaz seçimi konusunda şüpheye düşmeniz halinde satış bölümümüz ile temasa geçebilirsiniz.





BASINÇ

ÖLÇERLER

Ø40	Cl. 2,5	MANOMETRE	0/1..1,6..2,5..4..6..10..16..25..40..60..100..160..250..315..400 bar	(bar/psi)	040 100 <input type="checkbox"/>	Basınç Elemanı: Bakır Alaşımı	
	G 1/8"	VAKUMMETRE	-760/0 mmHg -1/0 bar Manovakummetre: -1/+0,6..1,5..3..5..9..15..24 bar	(mmHg) (bar/psi)	040 200 <input type="checkbox"/>	Bağlantı Elemanı: Piriç	
	IP41	HİDROMETRE	0/10..16..25..40..60..100 mWS	(mWS/bar)	040 300 <input type="checkbox"/>	Mekanizma : Piriç	



Metal Gövde
Akrilik Kapak
-1...60 bar
€4,60
100...400 bar
€4,75

Bağlantı Tipi No : - - - - - **01**

Alttan Bağlantılı



Plastik Gövde
Akrilik Kapak
-1...60 bar
€4,40
100...400 bar
€4,50

Bağlantı Tipi No : - - - - - **02**

Arkadan Bağlantılı



Metal Gövde
Akrilik Kapak
-1...60 bar
€4,50
100...400 bar
€4,60

Bağlantı Tipi No : - - - - - **02**

Arkadan Bağlantılı



Metal Gövde
Metal Kapak
-1...60 bar
€5,30
100...400 bar
€5,40

Bağlantı Tipi No : - - - - - **03**

Arkadan Bağlantılı Pano Tip



Plastik Gövde
Akrilik Kapak
€4,40

2 bar Kirlilik Göstergesi

Ürün Kodu : 040 100 02 03 10

Arkadan Bağlantılı



Plastik Gövde
Akrilik Kapak
€4,10

4 bar Kapiler Borulu (G1/4" - 1 mt)

Ürün Kodu : 040 100 09 05 10

Arkadan Bağlantılı

Ø50	Cl. 2,5	MANOMETRE	0/0,6..1.1,6..2,5..4..6..10..16..25..40..60..100..160..250..315..400..600 bar	(bar/psi)	050 100 <input type="checkbox"/>	Basınç Elemanı: Bakır Alaşımı	
	G 1/4"	VAKUMMETRE	-760/0 mmHg -1/0 bar Manovakummetre: -1/+0,6..1,5..3..5..9..15..24 bar	(mmHg) (bar/psi)	050 200 <input type="checkbox"/>	Bağlantı Elemanı: Piriç	
	IP41	HİDROMETRE	0/6..10..16..25..40..60..100 mWS	(mWS/bar)	050 300 <input type="checkbox"/>	Mekanizma : Piriç	



Plastik Gövde
Akrilik Kapak
-1...60 bar
€3,75
100...600 bar
€4,00

Bağlantı Tipi No : - - - - - **01**

Alttan Bağlantılı



Metal Gövde
Akrilik Kapak
-1...60 bar
€3,90
100...600 bar
€4,10

Bağlantı Tipi No : - - - - - **01**

Alttan Bağlantılı



Plastik Gövde
Akrilik Kapak
-1...60 bar
€4,55
100...600 bar
€4,80

Bağlantı Tipi No : - - - - - **02**

Arkadan Bağlantılı

G 1/8"



Metal Gövde
Akrilik Kapak
-1...60 bar
€4,75
100...600 bar
€5,00

Bağlantı Tipi No : - - - - - **02**

Arkadan Bağlantılı

G 1/8"



Metal Gövde
Metal Kapak
-1...60 bar
€5,50
100...600 bar
€5,75

Bağlantı Tipi No : - - - - - **03**

Arkadan Bağlantılı Pano Tip

G 1/8"

STANDART

Ø63

Cl. 2,5	MANOMETRE	0/0,6..1..1,6..2,5..4..6..10..16..25..40..60..100..160..250..315..400..600 bar	(bar/psi)
G 1/4"	VAKUMMETRE	-760/0 mmHg -1/0 bar Manovakummetre: -1/+0,6..1,5..3..5..9..15..24 bar	(mmHg) (bar/psi)
IP41	HİDROMETRE	0/6..10..16..25..40..60..100 mWS	(mWS/bar)

063 100

Basınç Elemanı: Bakır Alaşımı

063 200

Bağlantı Elemanı: Piriç

063 300

Mekanizma : Piriç



Metal Gövde
Akrilik Kapak
-1...60 bar
€4,00
100...600 bar
€4,20



Plastik Gövde
Akrilik Kapak
-1...60 bar
€3,80
100...600 bar
€4,00



Metal Gövde
Metal Kapak
-1...60 bar
€4,85
100...600 bar
€5,00

Bağlantı Tipi No : - - - - - 01
Alttan Bağlantılı



Bağlantı Tipi No : - - - - - 01
Alttan Bağlantılı



Bağlantı Tipi No : - - - - - 01
Alttan Bağlantılı



Metal Gövde
Akrilik Kapak
-1...60 bar
€4,70
100...600 bar
€4,90



Plastik Gövde
Akrilik Kapak
-1...60 bar
€4,65
100...600 bar
€4,85



Metal Gövde
Metal Kapak
-1...60 bar
€5,80
100...600 bar
€5,95

Bağlantı Tipi No : - - - - - 02
Arkadan Bağlantılı



Bağlantı Tipi No : - - - - - 02
Arkadan Bağlantılı



Bağlantı Tipi No : - - - - - 02
Arkadan Bağlantılı



Metal Gövde
Metal Kapak
-1...60 bar
€5,80
100...600 bar
€5,95



Metal Gövde
Akrilik Kapak
600 mbar
€5,00

Bağlantı Tipi No : - - - - - 03
Arkadan Bağlantılı Pano Tip



Ürün Kodu : 063 100 01 18 12
Alttan Bağlantılı



Ø100

Cl. 2,5	MANOMETRE	0/0,6..1..1,6..2,5..4..6..10..16..25..40..60..100..160..250..315..400..600 bar	(bar/psi)
G 1/2"	VAKUMMETRE	-760/0 mmHg -1/0 bar Manovakummetre: -1/+0,6..1,5..3..5..9..15..24 bar	(mmHg) (bar/psi)
IP41	HİDROMETRE	0/6..10..16..25..40..60..100 mWS	(mWS/bar)

100 100

Basınç Elemanı: Bakır Alaşımı

100 200

Bağlantı Elemanı: Piriç

100 300

Mekanizma : Piriç



Metal Gövde
Metal Kapak
-1...60 bar
€8,65
100...600 bar
€8,90



Metal Gövde
Akrilik Kapak
-1...60 bar
€6,85
100...600 bar
€7,10



Metal Gövde
Metal Kapak
-1...60 bar
€8,35
100...600 bar
€8,55

Bağlantı Tipi No : - - - - - 01
Alttan Bağlantılı



Bağlantı Tipi No : - - - - - 01
Alttan Bağlantılı



Bağlantı Tipi No : - - - - - 02
Arkadan Bağlantılı

G 1/4"



Hidrometre
İkaz İbrelili
(0/6..100 mWS/bar)
Metal Gövde
Akrilik Kapak
€7,25

Bağlantı Tipi No : - - - - - 01
Alttan Bağlantılı



STANDART

Ø160

CL. 1,6

G 1/2"

IP65

MANOMETRE

0/1..1,6..2,5..4..6..10..16..25..40..60..100..160..250..315..400..600 bar

bar/psi

160 100



Gövde: AISI 304 SS

Kapak: AISI 304 SS

Basınç Elemanı: Bakır Alaşımı

Bağlantı Elemanı: Piriç

Mekanizma : Piriç



VAKUMMETRE

-760/0 mmHg -1/0 bar Manovakummetre: -1/+0,6..1,5..3..5..9..15..24 bar

mmHg

bar/psi

160 200

**Kuru Tip**

0...6 bar

-1...5 bar

€29,70

Bağlantı Tipi No : - - - - - 71 Doldurulamaz

Alttan Bağlantılı

**Doldurulabilir Tip**

10...60 bar

-1/9...24 bar

€28,10

100...600 bar

€28,80

Bağlantı Tipi No : - - - - - 21

Alttan Bağlantılı



GLİSERİN DOLGULU

Ø40	Cl. 2,5	MANOMETRE	0/1..1,6..2,5..4..6..10..16..25..40..60..100..160..250..315..400 bar	bar/psi	040 100	<input type="checkbox"/>	Gövde: AISI 304 SS	
	G 1/8"	VAKUMMETRE	-760/0 mmHg -1/0 bar Manovakummetre: -1/+0,6..1,5..3..5..9..15..24 bar	mmHg bar/psi	040 200	<input type="checkbox"/>	Kapak: AISI 304 SS	
	IP67						Basınç Elemanı: Bakır Alaşımı	
							Mekanizma : Pirinç	



-1...400 bar
€10,70

Bağlantı Tipi No : - - - - - 12
Arkadan Bağlantılı

Ø50	Cl. 2,5	MANOMETRE	0/0,6..1..1,6..2,5..4..6..10..16..25..40..60..100..160..250..315..400..600 bar	bar/psi	050 100	<input type="checkbox"/>	Gövde: AISI 304 SS	
	G 1/4"	VAKUMMETRE	-760/0 mmHg -1/0 bar Manovakummetre: -1/+0,6..1,5..3..5..9..15..24 bar	mmHg bar/psi	050 200	<input type="checkbox"/>	Kapak: AISI 304 SS	
	IP65						Basınç Elemanı: Bakır Alaşımı	
							Bağlantı Elemanı: Pirinç	
							Mekanizma : Pirinç	



-1...60 bar
€7,50

100...600 bar
€7,60

Bağlantı Tipi No : - - - - - 11
Alttan Bağlantılı



-1...60 bar
€10,20

100...600 bar
€10,35

Bağlantı Tipi No : - - - - - 12
Arkadan Bağlantılı



-1...60 bar
€10,90

100...600 bar
€11,10

Bağlantı Tipi No : - - - - - 13
Arkadan Bağlantılı Panotip

Ø63	Cl. 2,5	MANOMETRE	0/0,6..1..1,6..2,5..4..6..10..16..25..40..60..100..160..250..315..400..600 bar	bar/psi	063 100	<input type="checkbox"/>	Gövde: AISI 304 SS	
	G 1/4"	VAKUMMETRE	-760/0 mmHg -1/0 bar Manovakummetre: -1/+0,6..1,5..3..5..9..15..24 bar	mmHg bar/psi	063 200	<input type="checkbox"/>	Kapak: AISI 304 SS	
	IP65						Basınç Elemanı: Bakır Alaşımı	
							Bağlantı Elemanı: Pirinç	
							Mekanizma : Pirinç	



-1...60 bar
€6,65

100...600 bar
€6,85

Bağlantı Tipi No : - - - - - 11
Alttan Bağlantılı



-1...60 bar
€8,25

100...600 bar
€8,45

Bağlantı Tipi No : - - - - - 12
Arkadan Bağlantılı



-1...60 bar
€9,55

100...600 bar
€9,70

Bağlantı Tipi No : - - - - - 13
Arkadan Bağlantılı Pano Tip

Ø100	Cl. 2,5	MANOMETRE	0/0,6..1..1,6..2,5..4..6..10..16..25..40..60..100..160..250..315..400..600 bar	bar/psi	100 100	<input type="checkbox"/>	Gövde: AISI 304 SS	
	G 1/2"	VAKUMMETRE	-760/0 mmHg -1/0 bar Manovakummetre: -1/+0,6..1,5..3..5..9..15..24 bar	mmHg bar/psi	100 200	<input type="checkbox"/>	Kapak: AISI 304 SS	
	IP65						Basınç Elemanı: Bakır Alaşımı	
							Bağlantı Elemanı: Pirinç	
							Mekanizma : Pirinç	



-1...60 bar
€15,95

100...600 bar
€16,40

Bağlantı Tipi No : - - - - - 11
Alttan Bağlantılı



-1...60 bar
€19,85

100...600 bar
€20,30

Bağlantı Tipi No : - - - - - 12
Arkadan Bağlantılı



-1...60 bar
€23,25

100...600 bar
€23,90

Bağlantı Tipi No : - - - - - 13
Arkadan Bağlantılı Pano Tip

CE 200 bar üzerindeki basınçlar için geçerlidir.

GLİSERİN DOLGULU

Ø160	Cl. 1,6	MANOMETRE	0/2,5..4..6..10..16..25..40..60..100..160..250..315..400..600 bar	bar/psi	160 100 <input type="checkbox"/>	Gövde: AISI 304 SS	  
	G 1/2"	MANOVAKUMMETRE	-1/+1,5..3..5..9..15..24 bar	bar/psi	160 200 <input type="checkbox"/>	Kapak: AISI 304 SS Basınç Elemanı: Bakır Alaşımı Bağlantı Elemanı: Pirinç Mekanizma : Pirinç	
	IP65						





-1...600 bar
€34,95

Bağlantı Tipi No : - - - - - **11**

Alttan Bağlantılı



KOMPLE PASLANMAZ

Ø63	Cl. 2,5	MANOMETRE	0/2,5..4..6..10..16..25..40..60..100..160..250..315..400..600 bar	bar/psi	063 101 <input type="checkbox"/>	Gövde: AISI 316L SS	  
	G 1/4"	MANOVAKUMMETRE	-1/+1,5..3..5..9..15..24 bar	bar/psi	063 201 <input type="checkbox"/>	Kapak: AISI 316L SS Basınç Elemanı: AISI 316L SS Bağlantı Elemanı: AISI 316L SS Mekanizma : Paslanmaz	
	IP65						

 Fiyat Sorunuz



-1...600 bar
€21,35

Bağlantı Tipi No : - - - - - **21**

Alttan Bağlantılı



 Fiyat Sorunuz



-1...600 bar
€24,45

Bağlantı Tipi No : - - - - - **24**

Arkadan Bağlantılı Eksenden Kaçık



 Fiyat Sorunuz



-1...600 bar
€27,05

Bağlantı Tipi No : - - - - - **25**

Arkadan Bağ. Eksenden Kaçık Pano Tip



GLİSERİN DOLGULU, KOMPLE PASLANMAZ

Ø63	Cl. 2,5	MANOMETRE	0/2,5..4..6..10..16..25..40..60..100..160..250..315..400..600 bar	bar/psi	063 101 <input type="checkbox"/>	Gövde: AISI 316L SS	  
	G 1/4"	MANOVAKUMMETRE	-1/+1,5..3..5..9..15..24 bar	bar/psi	063 201 <input type="checkbox"/>	Kapak: AISI 316L SS Basınç Elemanı: AISI 316L SS Bağlantı Elemanı: AISI 316L SS Mekanizma : Paslanmaz	
	IP65						

 Fiyat Sorunuz



-1...600 bar
€21,70

Bağlantı Tipi No : - - - - - **11**

Alttan Bağlantılı



 Fiyat Sorunuz



-1...600 bar
€24,75

Bağlantı Tipi No : - - - - - **14**

Arkadan Bağlantılı Eksenden Kaçık



 Fiyat Sorunuz



-1...600 bar
€27,35

Bağlantı Tipi No : - - - - - **15**

Arkadan Bağ. Eksenden Kaçık Pano Tip



STANDART

Ø100	Cl. 1.0	MANOMETRE	0/0,6..1..1,6..2,5..4..6..10..16..25..40..60..100..160..250..315..400..600 bar	bar/psi	100 110	<input type="checkbox"/>	Gövde: Metal (Siyah Boyalı)	
	G 1/2"	VAKUMMETRE	-760/0 mmHg -1/0 bar Manovakummetre: -1/+0,6..1,5..3..5..9..15..24 bar	mmHg bar/psi	100 210	<input type="checkbox"/>	Kapak: Metal (Bayonet, Siyah Boy.)	
	IP41						Basınç Elemanı: Bakır Alaşımı	
							Bağlantı Elemanı: Piringç	
							Mekanizma : Piringç	

	0,6..1,6 bar €33,25 2,5..600 bar €30,20		0,6..1,6 bar €36,50 2,5..600 bar €33,85		0,6..1,6 bar €38,20 2,5..600 bar €34,90
Bağlantı Tipi No : - - - - - 01 Alttan Bağlantılı		Bağlantı Tipi No : - - - - - 04 Arkadan Bağlantılı Eksenden Kaçık		Bağlantı Tipi No : - - - - - 05 Arkadan Bağlantılı Eksenden Kaçık Pano Tip	





Ø160	Cl. 1.0	MANOMETRE	0/0,6..1..1,6..2,5..4..6..10..16..25..40..60..100..160..250..315..400..600 bar	bar/psi	160 110	<input type="checkbox"/>	Gövde: Metal (Siyah Boyalı)	
	G 1/2"	VAKUMMETRE	-760/0 mmHg -1/0 bar Manovakummetre: -1/+0,6..1,5..3..5..9..15..24 bar	mmHg bar/psi	160 210	<input type="checkbox"/>	Kapak: Metal (Bayonet, Siyah Boy.)	
	IP41						Basınç Elemanı: Bakır Alaşımı	
							Bağlantı Elemanı: Piringç	
							Mekanizma : Piringç	

	0,6..1,6 bar €42,45 2,5..600 bar €38,25		0,6..1,6 bar €43,80 2,5..600 bar €39,90		0,6..1,6 bar €49,25 2,5..600 bar €44,75
Bağlantı Tipi No : - - - - - 01 Alttan Bağlantılı		Bağlantı Tipi No : - - - - - 04 Arkadan Bağlantılı Eksenden Kaçık		Bağlantı Tipi No : - - - - - 05 Arkadan Bağlantılı Eksenden Kaçık Pano Tip	





Ø250	Cl. 1.0	MANOMETRE	0/0,6..1..1,6..2,5..4..6..10..16..25..40..60..100..160..250..315..400..600 bar	bar/psi	250 110	<input type="checkbox"/>	Gövde: Metal (Siyah Boyalı)	
	G 1/2"	VAKUMMETRE	-760/0 mmHg -1/0 bar Manovakummetre: -1/+0,6..1,5..3..5..9..15..24 bar	mmHg bar/psi	250 210	<input type="checkbox"/>	Kapak: Metal (Siyah Boyalı)	
	IP41						Basınç Elemanı: Bakır Alaşımı	
							Bağlantı Elemanı: Piringç	
							Mekanizma : Piringç	

	0,6..1,6 bar €75,70 2,5..600 bar €71,70		0,6..1,6 bar €99,00 2,5..600 bar €95,60
Bağlantı Tipi No : - - - - - 01 Alttan Bağlantılı		Bağlantı Tipi No : - - - - - 02 Arkadan Bağlantılı	

SIVI DOLGULU

Ø100	Cl. 1,0	MANOMETRE VAKUMMETRE*	0/0,6..1..1,6..2,5..4..6..10..16..25..40..60..100..160..250..315..400..600 bar	bar/psi	100 110 <input type="checkbox"/>	Gövde: AISI 304 SS Kapak: AISI 304 SS (Bayonet) Basınç Elemanı: Bakır Alaşımı Bağlantı Elemanı: Pirinç Mekanizma : Pirinç	   	
	G 1/2"		-760/0 mmHg -1/0 bar *Manovakummetre: -1/+0,6..1,5..3..5..9..15..24 bar	mmHg	bar/psi			100 210 <input type="checkbox"/>
	IP65							

	0,6..1,6 bar €36,80 2,5..600 bar €34,40		0,6..1,6 bar €38,80 2,5..600 bar €37,10		0,6..1,6 bar €44,80 2,5..600 bar €42,80
Bağlantı Tipi No : - - - - - 11 Alttan Bağlantılı		Bağlantı Tipi No : - - - - - 14 Arkadan Bağlantılı Eksenden Kaçık		Bağlantı Tipi No : - - - - - 15 Arkadan Bağlantılı Eksenden Kaçık Pano Tip	

Ø160	Cl. 1,0	MANOMETRE VAKUMMETRE*	0/0,6..1..1,6..2,5..4..6..10..16..25..40..60..100..160..250..315..400..600 bar	bar/psi	160 110 <input type="checkbox"/>	Gövde: AISI 304 SS Kapak: AISI 304 SS (Bayonet) Basınç Elemanı: Bakır Alaşımı Bağlantı Elemanı: Pirinç Mekanizma : Piriç	   	
	G 1/2"		-760/0 mmHg -1/0 bar *Manovakummetre: -1/+0,6..1,5..3..5..9..15..24 bar	mmHg	bar/psi			160 210 <input type="checkbox"/>
	IP65							

	0,6..1,6 bar €55,20 2,5..600 bar €52,20		0,6..1,6 bar €56,90 2,5..600 bar €54,80		0,6..1,6 bar €69,60 2,5..600 bar €66,50
Bağlantı Tipi No : - - - - - 11 Alttan Bağlantılı		Bağlantı Tipi No : - - - - - 14 Arkadan Bağlantılı Eksenden Kaçık		Bağlantı Tipi No : - - - - - 15 Arkadan Bağlantılı Eksenden Kaçık Pano Tip	

KOMPLE PASLANMAZ

Ø100	Cl. 1,0	MANOMETRE	0/0,6..1..1,6..2,5..4..6..10..16..25..40..60..100..160..250..315..400..600..1000 bar	bar/psi	100 111	<input type="checkbox"/>	Gövde: AISI 316L SS	
	G 1/2"	VAKUMMETRE	-760/0 mmHg -1/0 bar Manovakummetre: -1/+0,6..1,5..3..5..9..15..24 bar	mmHg bar/psi	100 211	<input type="checkbox"/>	Kapak: AISI 316L SS (Bayonet)	
	IP65						Basınç Elemanı: AISI 316L SS	
							Bağlantı Elemanı: AISI 316L SS	
							Mekanizma : Paslanmaz	

Ex Fiyat Sorunuz

71 Doldurulamaz*

0,6..1,6 bar
€46,40

2,5..600 bar
€42,40

1000 bar
€47,80

Bağlantı Tipi No : - - - - - **21**

Alttan Bağlantılı

1

Ex Fiyat Sorunuz Request

74 Doldurulamaz*

0,6..1,6 bar
€48,70

2,5..600 bar
€47,70

1000 bar
€49,80

Bağlantı Tipi No : - - - - - **24**

Arkadan Bağlantılı Eksenden Kaçık

1

Ex Fiyat Sorunuz Request

75 Doldurulamaz*

0,6..1,6 bar
€52,60

2,5..600 bar
€53,30

1000 bar
€55,50

Bağlantı Tipi No : - - - - - **25**

Arkadan Bağlantılı Eksenden Kaçık Pano Tip

1

Ø160	Cl. 1,0	MANOMETRE	0/0,6..1..1,6..2,5..4..6..10..16..25..40..60..100..160..250..315..400..600..1000 bar	bar/psi	160 111	<input type="checkbox"/>	Gövde: AISI 316L SS	
	G 1/2"	VAKUMMETRE*	-760/0 mmHg -1/0 bar *Manovakummetre: -1/+0,6..1,5..3..5..9..15..24 bar	mmHg bar/psi	160 211	<input type="checkbox"/>	Kapak: AISI 316L SS (Bayonet)	
	IP65						Basınç Elemanı: AISI 316L SS	
							Bağlantı Elemanı: AISI 316L SS	
							Mekanizma : Paslanmaz	

Ex Fiyat Sorunuz

71 Doldurulamaz*

0,6..1,6 bar
€60,00

2,5..600 bar
€58,40

1000 bar
€65,60

Bağlantı Tipi No : - - - - - **21**

Alttan Bağlantılı

1

Ex Fiyat Sorunuz

74 Doldurulamaz*

0,6..1,6 bar
€67,00

2,5..600 bar
€63,00

1000 bar
€70,00

Bağlantı Tipi No : - - - - - **24**

Arkadan Bağlantılı Eksenden Kaçık

1

Ex Fiyat Sorunuz

75 Doldurulamaz*

0,6..1,6 bar
€68,00

2,5..600 bar
€65,00

1000 bar
€71,00

Bağlantı Tipi No : - - - - - **25**

Arkadan Bağlantılı Eksenden Kaçık Pano Tip

1

Ø250	Cl. 1,0	MANOMETRE	0/0,6..1..1,6..2,5..4..6..10..16..25..40..60..100..160..250..315..400..600..1000 bar	bar/psi	250 111	<input type="checkbox"/>	Gövde: AISI 304 SS	
	G 1/2"	VAKUMMETRE*	-760/0 mmHg -1/0 bar *Manovakummetre: -1/+0,6..1,5..3..5..9..15..24 bar	mmHg bar/psi	250 211	<input type="checkbox"/>	Kapak: AISI 304 SS	
	IP41						Basınç Elemanı: AISI 316L SS	
							Bağlantı Elemanı: AISI 316L SS	
							Mekanizma : Paslanmaz	

Ex Fiyat Sorunuz

01

Bağlantı Tipi No : - - - - - **01**



Alttan Bağlantılı

1

CE 200 bar üzerindeki basınçlar için geçerlidir.

* Ø100 ve Ø160 mm, 0,6..1,6 bar komple paslanmaz ürünlere dolum yapıldığında hatalı okumaya sebep olabilir. Dolum yapılmamalıdır.

KOMPLE PASLANMAZ, SIVI DOLGULU

Ø100	Cl. 1,0	MANOMETRE	0/0,6..1..1,6..2,5..4..6..10..16..25..40..60..100..160..250..315..400..600..1000 bar	bar/psi	100 111	<input type="checkbox"/>	Gövde: AISI 316L SS	  
	G 1/2"	VAKUMMETRE	-760/0 mmHg -1/0 bar Manovakummetre: -1/+0,6..1,5..3..5..9..15..24 bar	mmHg bar/psi	100 211	<input type="checkbox"/>	Kapak: AISI 316L SS (Bayonet) Basınç Elemanı: AISI 316L SS Bağlantı Elemanı: AISI 316L SS Mekanizma : Paslanmaz	
	IP65							

Ex Fiyat Sorunuz



0,6..1,6 bar
€46,80

2,5..600 bar
€43,80

1000 bar
€49,30

Bağlantı Tipi No : - - - - - **11**

Alttan Bağlantılı

1

Ex Fiyat Sorunuz



0,6..1,6 bar
€50,30

2,5..600 bar
€49,30

1000 bar
€54,80

Bağlantı Tipi No : - - - - - **14**

Arkadan Bağlantılı Eksenden Kaçık

1

Ex Fiyat Sorunuz



0,6..1,6 bar
€54,40



2,5..600 bar
€55,10

1000 bar
€60,40

Bağlantı Tipi No : - - - - - **15**

Arkadan Bağlantılı Eksenden Kaçık Pano Tip

1

Ø160	Cl. 1,0	MANOMETRE	0/0,6..1..1,6..2,5..4..6..10..16..25..40..60..100..160..250..315..400..600..1000 bar	bar/psi	160 111	<input type="checkbox"/>	Gövde: AISI 316L SS	  
	G 1/2"	VAKUMMETRE	-760/0 mmHg -1/0 bar Manovakummetre: -1/+0,6..1,5..3..5..9..15..24 bar	mmHg bar/psi	160 211	<input type="checkbox"/>	Kapak: AISI 316L SS (Bayonet) Basınç Elemanı: AISI 316L SS Bağlantı Elemanı: AISI 316L SS Mekanizma : Paslanmaz	
	IP65							

Ex Fiyat Sorunuz



0,6..1,6 bar
€64,00

2,5..600 bar
€62,40

1000 bar
€69,60

Bağlantı Tipi No : - - - - - **11**

Alttan Bağlantılı

1

Ex Fiyat Sorunuz



0,6..1,6 bar
€71,00

2,5..600 bar
€68,10

1000 bar
€73,80

Bağlantı Tipi No : - - - - - **14**

Arkadan Bağlantılı Eksenden Kaçık

1

Ex Fiyat Sorunuz



0,6..1,6 bar
€73,00

2,5..600 bar
€70,10

1000 bar
€70,80

Bağlantı Tipi No : - - - - - **15**

Arkadan Bağlantılı Eksenden Kaçık Pano Tip

1

SOLID FRONT

Ø100

Cl. 1,0

G 1/2"

IP65

MANOMETRE

0/0,6..1..1,6..2,5..4..6..10..16..25..40..60..100..160..250..315..400..600..1000 bar (bar/psi)

100 111

Gövde: AISI 316L SS

Kapak: AISI 316L SS (Bayonet)

Basınç Elemanı: AISI 316L SS

Bağlantı Elemanı: AISI 316L SS

Mekanizma : Paslanmaz



Ex



İsteğe bağlı sıvı dolgulu üretilmektedir.

Bağlantı Tipi No : - - - - - 51 61 Sıvı Dolgulu

Alttan Bağlantılı



Ø160

Cl. 1,0

G 1/2"

IP65

MANOMETRE

0/0,6..1..1,6..2,5..4..6..10..16..25..40..60..100..160..250..315..400..600..1000 bar (bar/psi)

160 111

Gövde: AISI 316L SS

Kapak: AISI 316L SS (Bayonet)

Basınç Elemanı: AISI 316L SS

Bağlantı Elemanı: AISI 316L SS

Mekanizma : Paslanmaz



Ex





İsteğe bağlı sıvı dolgulu üretilmektedir.

Bağlantı Tipi No : - - - - - 51 61 Sıvı Dolgulu

Alttan Bağlantılı



NO - NC - NCNO - NONC - NONO-NCNC **STANDART**

Ø100	CL 1,0	MANOMETRE	0/0,6..1..1,6..2,5..4..6..10..16..25..40..60..100..160..250..315..400..600 bar	bar	100 110	<input type="checkbox"/>	Gövde: AISI 304 SS	  
	G 1/2"	VAKUMMETRE	-760/0 mmHg -1/0 bar *Manovakummetre: -1/+0,6..1,5..3..5..9..15..24 bar	mmHg bar	100 210	<input type="checkbox"/>	Kapak: AISI 304 SS (Bayonet) Basınç Elemanı: Bakır Alaşımı Bağlantı Elemanı: Piring Mekanizma : Piring	
	IP65							



TEK KONTAKLI
€100,00
ÇİFT KONTAKLI
€120,00

24V-250V
Max. 0,6A
Max. 30W=50VA

Bağlantı Tipi No : - - - - - 71 Doldurulamaz

Alttan Bağlantılı



TEK KONTAKLI
€103,00
ÇİFT KONTAKLI
€123,00

24V-250V
Max. 0,6A
Max. 30W=50VA

Bağlantı Tipi No : - - - - - 74 Doldurulamaz

Arkadan Bağlantılı Eksenden Kaçık





TEK KONTAKLI
€109,00
ÇİFT KONTAKLI
€129,00

24V-250V
Max. 0,6A
Max. 30W=50VA

Bağlantı Tipi No : - - - - - 75 Doldurulamaz

Arkadan Bağlantılı Eksenden Kaçık Pano Tip

Ø160	CL 1,0	MANOMETRE	0/0,6..1..1,6..2,5..4..6..10..16..25..40..60..100..160..250..315..400..600 bar	bar	160 110	<input type="checkbox"/>	Gövde: AISI 304 SS	  
	G 1/2"	VAKUMMETRE	-760/0 mmHg -1/0 bar Manovakummetre: -1/+0,6..1,5..3..5..9..15..24 bar	mmHg bar	160 210	<input type="checkbox"/>	Kapak: AISI 304 SS (Bayonet) Basınç Elemanı: Bakır Alaşımı Bağlantı Elemanı: Piring Mekanizma : Piring	
	IP65							



TEK KONTAKLI
€120,00
ÇİFT KONTAKLI
€140,00

24V-250V
Max. 0,6A
Max. 30W=50VA

Bağlantı Tipi No : - - - - - 71 Doldurulamaz

Alttan Bağlantılı



TEK KONTAKLI
€123,00
ÇİFT KONTAKLI
€143,00

24V-250V
Max. 0,6A
Max. 30W=50VA

Bağlantı Tipi No : - - - - - 74 Doldurulamaz

Arkadan Bağlantılı Eksenden Kaçık





TEK KONTAKLI
€134,00
ÇİFT KONTAKLI
€154,00

24V-250V
Max. 0,6A
Max. 30W=50VA

Bağlantı Tipi No : - - - - - 75 Doldurulamaz

Arkadan Bağlantılı Eksenden Kaçık Pano Tip

NO - NC - NCNO - NONC - NONO-NCNC **STANDART SİLİKON DOLGULU**

Ø100	CL 1,0	MANOMETRE	0/0,6..1..1,6..2,5..4..6..10..16..25..40..60..100..160..250..315..400..600 bar	bar	100 110	<input type="checkbox"/>	Gövde: AISI 304 SS	  
	G 1/2"	VAKUMMETRE	-760/0 mmHg -1/0 bar Manovakummetre: -1/+0,6..1,5..3..5..9..15..24 bar	mmHg bar	100 210	<input type="checkbox"/>	Kapak: AISI 304 SS (Bayonet) Basınç Elemanı: Bakır Alaşımı Bağlantı Elemanı: Piring Mekanizma : Piring	
	IP65							



TEK KONTAKLI
€133,00
ÇİFT KONTAKLI
€153,00

24V-250V
Max. 0,6A
Max. 30W=50VA

Bağlantı Tipi No : - - - - - 11

Alttan Bağlantılı



TEK KONTAKLI
€138,00
ÇİFT KONTAKLI
€158,00

24V-250V
Max. 0,6A
Max. 30W=50VA

Bağlantı Tipi No : - - - - - 14

Arkadan Bağlantılı Eksenden Kaçık





TEK KONTAKLI
€144,00
ÇİFT KONTAKLI
€164,00

24V-250V
Max. 0,6A
Max. 30W=50VA

Bağlantı Tipi No : - - - - - 15

Arkadan Bağlantılı Eksenden Kaçık Pano Tip

Ø160	CL 1,0	MANOMETRE	0/0,6..1..1,6..2,5..4..6..10..16..25..40..60..100..160..250..315..400..600 bar	bar	160 110	<input type="checkbox"/>	Gövde: AISI 304 SS	  
	G 1/2"	VAKUMMETRE	-760/0 mmHg -1/0 bar Manovakummetre: -1/+0,6..1,5..3..5..9..15..24 bar	mmHg bar	160 210	<input type="checkbox"/>	Kapak: AISI 304 SS (Bayonet) Basınç Elemanı: Bakır Alaşımı Bağlantı Elemanı: Piring Mekanizma : Piring	
	IP65							



TEK KONTAKLI
€177,00
ÇİFT KONTAKLI
€197,00

24V-250V
Max. 0,6A
Max. 30W=50VA

Bağlantı Tipi No : - - - - - 11

Alttan Bağlantılı



TEK KONTAKLI
€183,00
ÇİFT KONTAKLI
€203,00

24V-250V
Max. 0,6A
Max. 30W=50VA

Bağlantı Tipi No : - - - - - 14

Arkadan Bağlantılı Eksenden Kaçık



TEK KONTAKLI
€185,00
ÇİFT KONTAKLI
€205,00

24V-250V
Max. 0,6A
Max. 30W=50VA

Bağlantı Tipi No : - - - - - 15

Arkadan Bağlantılı Eksenden Kaçık Pano Tip

CE 200 bar üzerindeki basınçlar için geçerlidir.

KOMPLE PASLANMAZ NO - NC - NCNO - NONC - NONO-NCNC

Ø100	CL 1,0	MANOMETRE	0/0,6..1..1,6..2,5..4..6..10..16..25..40..60..100..160..250..315..400..600..1000 bar	bar	100 111	<input type="checkbox"/>	Gövde: AISI 316L SS Kapak: AISI 316L SS (Bayonet) Basınç Elemanı: AISI 316L SS Bağlantı Elemanı: AISI 316L SS Mekanizma : Paslanmaz	
	G 1/2"	VAKUMMETRE	-760/0 mmHg -1/0 bar Manovakummetre: -1/+0,6..1,5..3..5..9..15..24 bar	mmHg bar	100 211	<input type="checkbox"/>		
	IP65							

Ex Fiyat Sorunuz



TEK KONTAKLI
€115,00
ÇİFT KONTAKLI
€135,00

Bağlantı Tipi No : - - - - - 71 Doldurulamaz

Alttan Bağlantılı

1

Ex Fiyat Sorunuz



TEK KONTAKLI
€120,00
ÇİFT KONTAKLI
€140,00

Bağlantı Tipi No : - - - - - 74 Doldurulamaz

Arkadan Bağlantılı Eksenden Kaçık

1

Ex Fiyat Sorunuz



TEK KONTAKLI
€125,00
ÇİFT KONTAKLI
€145,00

Bağlantı Tipi No : - - - - - 75 Doldurulamaz

Arkadan Bağlantılı Eksenden Kaçık Pano Tip

1

Ø160	CL 1,0	MANOMETRE	0/0,6..1..1,6..2,5..4..6..10..16..25..40..60..100..160..250..315..400..600..1000 bar	bar	160 111	<input type="checkbox"/>	Gövde: AISI 316L SS Kapak: AISI 316L SS (Bayonet) Basınç Elemanı: AISI 316L SS Bağlantı Elemanı: AISI 316L SS Mekanizma : Paslanmaz	
	G 1/2"	VAKUMMETRE	-760/0 mmHg -1/0 bar Manovakummetre: -1/+0,6..1,5..3..5..9..15..24 bar	mmHg bar	160 211	<input type="checkbox"/>		
	IP65							

Ex Fiyat Sorunuz



TEK KONTAKLI
€129,00
ÇİFT KONTAKLI
€149,00

Bağlantı Tipi No : - - - - - 71 Doldurulamaz

Alttan Bağlantılı

1

Ex Fiyat Sorunuz



TEK KONTAKLI
€135,00
ÇİFT KONTAKLI
€155,00

Bağlantı Tipi No : - - - - - 74 Doldurulamaz

Arkadan Bağlantılı Eksenden Kaçık

1

Ex Fiyat Sorunuz



TEK KONTAKLI
€137,00
ÇİFT KONTAKLI
€157,00

Bağlantı Tipi No : - - - - - 75 Doldurulamaz

Arkadan Bağlantılı Eksenden Kaçık Pano Tip

1

KOMPLE PASLANMAZ, SİLİKON DOLGULU NO - NC - NCNO - NONC - NONO-NCNC

Ø100	CL 1,0	MANOMETRE	0/0,6..1..1,6..2,5..4..6..10..16..25..40..60..100..160..250..315..400..600..1000 bar	bar	100 111	<input type="checkbox"/>	Gövde: AISI 316L SS Kapak: AISI 316L SS (Bayonet) Basınç Elemanı: AISI 316L SS Bağlantı Elemanı: AISI 316L SS Mekanizma : Paslanmaz	
	G 1/2"	VAKUMMETRE	-760/0 mmHg -1/0 bar Manovakummetre: -1/+0,6..1,5..3..5..9..15..24 bar	mmHg bar	100 211	<input type="checkbox"/>		
	IP65							

Ex Fiyat Sorunuz



TEK KONTAKLI
€139,00
ÇİFT KONTAKLI
€159,00

Bağlantı Tipi No : - - - - - 11

Alttan Bağlantılı

1

Ex Fiyat Sorunuz



TEK KONTAKLI
€143,00
ÇİFT KONTAKLI
€163,00

Bağlantı Tipi No : - - - - - 14

Arkadan Bağlantılı Eksenden Kaçık

1

Ex Fiyat Sorunuz



TEK KONTAKLI
€157,00
ÇİFT KONTAKLI
€177,00

Bağlantı Tipi No : - - - - - 15

Arkadan Bağlantılı Eksenden Kaçık Pano Tip

1

Ø160	CL 1,0	MANOMETRE	0/0,6..1..1,6..2,5..4..6..10..16..25..40..60..100..160..250..315..400..600..1000 bar	bar	160 111	<input type="checkbox"/>	Gövde: AISI 316L SS Kapak: AISI 316L SS (Bayonet) Basınç Elemanı: AISI 316L SS Bağlantı Elemanı: AISI 316L SS Mekanizma : Paslanmaz	
	G 1/2"	VAKUMMETRE	-760/0 mmHg -1/0 bar Manovakummetre: -1/+0,6..1,5..3..5..9..15..24 bar	mmHg bar	160 211	<input type="checkbox"/>		
	IP65							

Ex Fiyat Sorunuz



TEK KONTAKLI
€179,00
ÇİFT KONTAKLI
€199,00

Bağlantı Tipi No : - - - - - 11

Alttan Bağlantılı

1

Ex Fiyat Sorunuz



TEK KONTAKLI
€186,00
ÇİFT KONTAKLI
€206,00

Bağlantı Tipi No : - - - - - 14

Arkadan Bağlantılı Eksenden Kaçık

1

Ex Fiyat Sorunuz



TEK KONTAKLI
€192,00
ÇİFT KONTAKLI
€212,00

Bağlantı Tipi No : - - - - - 15

Arkadan Bağlantılı Eksenden Kaçık Pano Tip

1

CE 200 bar üzerindeki basınçlar için geçerlidir.

MANO TRANSMİTERLER

Ø100 Ø160	CL 1,0	MANO TRANSMİTER (Ø100) -1/0..0/1..1,6..2,5..4..6..10..16..25..40..60 bar	bar/psi	MT100 111 71	Gövde: AISI 316L SS Kapak: AISI 316L SS (Bayonet) Basınç Elemanı: AISI 316L SS Bağlantı Elemanı: AISI 316L SS Mekanizma : Paslanmaz
	G 1/2" IP65	MANO TRANSMİTER (Ø160) -1/0..0/1..1,6..2,5..4..6..10..16..25..40..60..100..160..250..400..600 bar	bar/psi	MT160 111 71	



Ø100
Seramik Sensör
€148,00

4-20 mA - bar
Büyük Soket

Linearity : 0,5% (FS)
Accuracy : 1,0% (FS)



Ø160
Seramik Sensör
€172,00

4-20 mA - bar
Büyük Soket

Linearity : 0,5% (FS)
Accuracy : 1,0% (FS)

TRANSMİTERLER

MPS-10 MPS-20	IP65	MPS-10	-1/0..0/0,5..1..1,6..2,5..4..5..6..10..16..20..25..40..60..100..160..250..400..600 bar	4-20 mA / bar	Gövde: AISI 316L SS
		MPS-20	0/6..10..16..25..40..60..100..160..250..400..600 bar	4-20 mA / bar	



MPS-10
Seramik Sensör

EN 175301-803 C
M12x1 Soket
EN 175301-803 A

Linearity : 0,5% (FS)
Accuracy : 1,0% (FS)



MPS-20
Thin Film Sensor

Linearity : 0,5% (FS)
Accuracy : 1,2% (FS)

Model No:	Soket	Bağlantı	Basınç Aralığı (bar)	€
71011100../MPS10	EN 175301-803 C	G 1/4"	1-4	78,50
			6-25	63,00
			40-600	86,00
71011101../MPS10	EN 175301-803 C	G 1/2"	1-4	80,50
			6-25	65,00
			40-600	88,00
71011100../EX/MPS10	EN 175301-803 C	G 1/4"	1-4 6-25 40-600	Fiyat sorunuz.
71011101../EX/MPS10	EN 175301-803 C	G 1/2"		
71061100../MPS10	M12x1 Soket	G 1/4"		
71061101../MPS10	M12x1 Soket	G 1/2"		
71061100../EX/MPS10	M12x1 Soket	G 1/4"		
71061101../EX/MPS10	M12x1 Soket	G 1/2"		
71031100../MPS10	EN 175301-803 A	G 1/4"		
71031101../MPS10	EN 175301-803 A	G 1/2"		
71031100../EX/MPS10	EN 175301-803 A	G 1/4"		
71031101../EX/MPS10	EN 175301-803 A	G 1/2"		

Model No:	Bağlantı	Soket	€
71011100../MPS20	G 1/4"	DIN 175301-803 A	Fiyat sorunuz.

STANDART

Ø63	CL 1,6	MANOMETRE	0/25..40..60..100..160..250..400..600..1000 mbar	mbar	063 130	<input type="checkbox"/>	Gövde: Metal (Sarı Boyalı)	 
	G 1/4"	VAKUMMETRE	-25/0..-40..-60..-100..-160..-250..-400..-600..-1000 mbar	mbar	063 230	<input type="checkbox"/>	Kapak: Akrilik Basınç Elemanı: Bakır Alaşımı Bağlantı Elemanı: Piring Mekanizma : Piring	
	IP41							



€17,90

Vakummetre için fiyat sorunuz.

Bağlantı Tipi No : - - - - - 01

Alttan Bağlantılı



€21,10

Vakummetre için fiyat sorunuz.

Bağlantı Tipi No : - - - - - 02

Arkadan Bağlantılı



€22,50



Metal Gövde (Çinko Kaplama)
Metal Kapak (AISI 430)

Vakummetre için fiyat sorunuz.

Bağlantı Tipi No : - - - - - 03

Arkadan Bağlantılı Pano Tip



Ø70	CL 1,6	VAKUMMETRE	-16/0..-25..-40..-60..-100..-160..-250..-400..-600..-1000 mbar	mbar	070 230	<input type="checkbox"/>	Gövde: Metal (Sarı Boyalı) Kapak: Metal (Sarı Boyalı) Basınç Elemanı: Bakır Alaşımı Bağlantı Elemanı: Piring Mekanizma : Piring	 
	G 1/2"							
	IP41							





€25,20

Ürün Kodu : 070 230 01 13 10

Alttan Bağlantılı Önden Flanşlı



Ø100	CL 1,6	MANOMETRE	0/16..25..40..60..100..160..250..400..600..1000 mbar	mbar	100 130	<input type="checkbox"/>	Gövde: Metal (Sarı Boyalı) Kapak: Metal (Sarı Boyalı) Basınç Elemanı: Bakır Alaşımı Bağlantı Elemanı: Piring Mekanizma : Piring	 
	G 1/2"	VAKUMMETRE	-16/0..-25..-40..-60..-100..-160..-250..-400..-600..-1000 mbar	mbar	100 230	<input type="checkbox"/>		
	IP41							



€37,40

Vakummetre için fiyat sorunuz.

Bağlantı Tipi No : - - - - - 01

Alttan Bağlantılı



€43,40

Vakummetre için fiyat sorunuz.

Bağlantı Tipi No : - - - - - 02

Arkadan Bağlantılı







€47,40

Vakummetre için fiyat sorunuz.

Bağlantı Tipi No : - - - - - 03

Arkadan Bağlantılı Pano Tip



Ø160	CL 1,6	MANOMETRE	0/2,5..4..6..10..16..25..40..60..100..160..250..400..600..1000 mbar	mbar	160 130	<input type="checkbox"/>	Gövde: Metal (Sarı Boyalı) Kapak: Metal (Sarı Boyalı) Basınç Elemanı: Bakır Alaşımı Bağlantı Elemanı: Piring Mekanizma : Piring	 
	G 1/2"	VAKUMMETRE	-2,5/0..-16..-25..-40..-60..-100..-160..-250..-400..-600..-1000 mbar	mbar	160 230	<input type="checkbox"/>		
	IP41							





2,5..25 mbar
Fiyat sorunuz.

40..1000 mbar
€53,80

Vakummetre için fiyat sorunuz.

Bağlantı Tipi No : - - - - - 01

Alttan Bağlantılı



16..25 mbar
Fiyat sorunuz.

40..1000 mbar
€58,60

Vakummetre için fiyat sorunuz.

Bağlantı Tipi No : - - - - - 02

Arkadan Bağlantılı

16..25 mbar
Fiyat sorunuz.

40..1000 mbar
€64,10

Vakummetre için fiyat sorunuz.

Bağlantı Tipi No : - - - - - 03

Arkadan Bağlantılı Pano Tip



SIVI DOLGULU

Ø63	CL 1,6	MANOMETRE	0/100..160..250..400..600..1000 mbar	mbar	063 130 <input type="checkbox"/>	Gövde: AISI 304 SS	
	G 1/4"	VAKUMMETRE*	-100/0..-160..-250..-400..-600..-1000 mbar	mbar	063 230 <input type="checkbox"/>	Kapak: AISI 304 SS	
	IP65					Basınç Elemanı: Bakır Alaşımı Bağlantı Elemanı: Piriñç Mekanizma : Piriñç	

100..1000 mbar
€24,00

Vakummetre için fiyat sorunuz.

Bağlantı Tipi No : - - - - - **11**

Alttan Bağlantılı



160..1000 mbar
€25,40

Vakummetre için fiyat sorunuz.

Bağlantı Tipi No : - - - - - **12**

Arkadan Bağlantılı



160..1000 mbar
€27,20

Vakummetre için fiyat sorunuz.

Bağlantı Tipi No : - - - - - **13**

Arkadan Bağlantılı Pano Tip



Ø100	CL 1,6	MANOMETRE	0/60..100..160..250..400..600..1000 mbar	mbar	100 130 <input type="checkbox"/>	Gövde: AISI 304 SS	
	G 1/2"	VAKUMMETRE	-60/0..-100..-160..-250..-400..-600..-1000 mbar	mbar	100 230 <input type="checkbox"/>	Kapak: AISI 304 SS (Bayonet)	
	IP65					Basınç Elemanı: Bakır Alaşımı Bağlantı Elemanı: Piriñç Mekanizma : Piriñç	

€45,60

Vakummetre için fiyat sorunuz.

Bağlantı Tipi No : - - - - - **11**

Alttan Bağlantılı



€51,70

Vakummetre için fiyat sorunuz.

Bağlantı Tipi No : - - - - - **12**

Arkadan Bağlantılı



€55,70

Vakummetre için fiyat sorunuz.

Bağlantı Tipi No : - - - - - **13**

Arkadan Bağlantılı Pano Tip



Ø160	CL 1,6	MANOMETRE	0/60..100..160..250..400..600..1000 mbar	mbar	160 130 <input type="checkbox"/>	Gövde: AISI 304 SS	
	G 1/2"	VAKUMMETRE	-60/0..-100..-160..-250..-400..-600..-1000 mbar	mbar	160 230 <input type="checkbox"/>	Kapak: AISI 304 SS (Bayonet)	
	IP65					Basınç Elemanı: Bakır Alaşımı Bağlantı Elemanı: Piriñç Mekanizma : Piriñç	

€62,50

Vakummetre için fiyat sorunuz.

Bağlantı Tipi No : - - - - - **11**

Alttan Bağlantılı



€67,30

Vakummetre için fiyat sorunuz.

Bağlantı Tipi No : - - - - - **12**

Arkadan Bağlantılı



€71,50

Vakummetre için fiyat sorunuz.

Bağlantı Tipi No : - - - - - **13**

Arkadan Bağlantılı Pano Tip



KOMPLE PASLANMAZ

Ø100	CL 1,6	MANOMETRE	0/25..40..60..100..160..250..400..600..1000 mbar	mbar	100 131	<input type="checkbox"/>	Gövde: AISI 316L SS Kapak: AISI 316L SS (Bayonet) Basınç Elemanı: AISI 316L SS Bağlantı Elemanı: AISI 316L SS Mekanizma : Paslanmaz	
	G 1/2"	VAKUMMETRE	-25/0..-40..-60..-100..-160..-250..-400..-600..-1000 mbar	mbar	100 231	<input type="checkbox"/>		
	IP41							



€109,00

Vakummetre için fiyat sorunuz.

Bağlantı Tipi No : - - - - - 01

Alttan Bağlantılı



€111,00

Vakummetre için fiyat sorunuz.

Bağlantı Tipi No : - - - - - 02

Arkadan Bağlantılı



€113,00

Vakummetre için fiyat sorunuz.

Bağlantı Tipi No : - - - - - 03

Arkadan Bağlantılı Pano Tip



Ø160	CL 1,6	MANOMETRE	0/6..10..16..25..40..60..100..160..250..400..600..1000 mbar	mbar	160 131	<input type="checkbox"/>	Gövde: AISI 316L SS Kapak: AISI 316L SS (Bayonet) Basınç Elemanı: AISI 316L SS Bağlantı Elemanı: AISI 316L SS Mekanizma : Paslanmaz	
	G 1/2"	VAKUMMETRE	-6/0..-10..-25..-40..-60..-100..-160..-250..-400..-600..-1000 mbar	mbar	160 231	<input type="checkbox"/>		
	IP41							



6..25 mbar

Fiyat sorunuz.

40..1000 mbar

€141,00

Vakummetre için fiyat sorunuz.

Bağlantı Tipi No : - - - - - 01

Alttan Bağlantılı



25..1000 mbar

€145,00

Vakummetre için fiyat sorunuz.

Bağlantı Tipi No : - - - - - 02

Arkadan Bağlantılı



25..1000 mbar

€151,00

Vakummetre için fiyat sorunuz.

Bağlantı Tipi No : - - - - - 03

Arkadan Bağlantılı Pano Tip



KOMPLE PASLANMAZ, SIVI DOLGULU

Ø100	CL 1,6	MANOMETRE	0/60..100..160..250..400..600..1000 mbar	mbar	100 131	<input type="checkbox"/>	Gövde: AISI 316L SS Kapak: AISI 316L SS (Bayonet) Basınç Elemanı: AISI 316L SS Bağlantı Elemanı: AISI 316L SS Mekanizma : Paslanmaz	
	G 1/2"	VAKUMMETRE	-60/0..-100..-160..-250..-400..-600..-1000 mbar	mbar	100 231	<input type="checkbox"/>		
	IP65							



€116,00

Vakummetre için fiyat sorunuz.



Fiyat Sorunuz

Bağlantı Tipi No : - - - - - 11

Alttan Bağlantılı



€118,00

Vakummetre için fiyat sorunuz.



Fiyat Sorunuz

Bağlantı Tipi No : - - - - - 12

Arkadan Bağlantılı



€120,00

Vakummetre için fiyat sorunuz.



Fiyat Sorunuz

Bağlantı Tipi No : - - - - - 13

Arkadan Bağlantılı Pano Tip



Ø160	CL 1,6	MANOMETRE	0/60..100..160..250..400..600..1000 mbar	mbar	160 131	<input type="checkbox"/>	Gövde: AISI 316L SS Kapak: AISI 316L SS (Bayonet) Basınç Elemanı: AISI 316L SS Bağlantı Elemanı: AISI 316L SS Mekanizma : Paslanmaz	
	G 1/2"	VAKUMMETRE*	-60/0..-100..-160..-250..-400..-600..-1000 mbar	mbar	160 231	<input type="checkbox"/>		
	IP65							



€149,00

Vakummetre için fiyat sorunuz.



Fiyat Sorunuz

Bağlantı Tipi No : - - - - - 11

Alttan Bağlantılı



€153,00

Vakummetre için fiyat sorunuz.



Fiyat Sorunuz

Bağlantı Tipi No : - - - - - 12

Arkadan Bağlantılı



€158,00

Vakummetre için fiyat sorunuz.



Fiyat Sorunuz

Bağlantı Tipi No : - - - - - 13

Arkadan Bağlantılı Pano Tip



STATİK BASINÇ TAM SKALA X 1,3

Ø100 Cl. 1.6 KAPSÜL DİYAFRAMLI FARK BASINÇ ÖLÇER 0/25..40..60..100..160..250..400..600..1000 mbar

Gövde: AISI 304L SS
Kapak: AISI 316L SS
Basınç Elemanı: Paslanmaz
Bağlantı Elemanı: AISI 316L SS
Mekanizma: Paslanmaz

mbar

IP65

Fiyat sorunuz.



P+/G 1/2"
P-/G 1/2"

Model No: 100 161 71../0591

Alttan Bağlantı

1

Fiyat sorunuz.



P+/G 1/2"
P-/G 1/2"

Model No: 100 161 72../0591

Arkadan Bağlantı

1

Fiyat sorunuz.



P+/G 1/2"
P-/G 1/2"

Gövde: AISI 304 SS
Kapak: AISI 304 SS
Basınç Elemanı: Bakır Alaşım
Bağlantı Elemanı: Pirinç
Mekanizma: Pirinç

Model No: 100 160 76../0591

Alttan Bağlantı, Arkadan Flanşlı

1

Ø100 Cl. 1.0 BOURDON BORULU FARK BASINÇ ÖLÇER

Kuru Tip: 0,3/0/0,3...0,5/0/0,5 0,8/0/0,8 bar
Doldurulabilir Tip: 1,25/0/1,25...2/0/2...3/0/3...5/0/5...8/0/8...12,5/0/12,5...20/0/20...30/0/30 bar

Gövde: AISI 304L SS
Kapak: AISI 316L SS
Basınç Elemanı: AISI 316L SS
Bağlantı Elemanı: AISI 316L SS
Mekanizma: Paslanmaz

bar

IP65

P+/G 1/2"
P-/G 1/2"

Fiyat sorunuz.

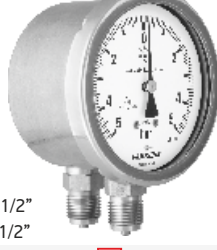

P+/G 1/2"
P-/G 1/2"

Model No: 100 161 []../0397

Alttan Bağlantı

Bağlantı Tipi No : - - - - 71 IP65, Kuru Tip Doldurulamaz
Bağlantı Tipi No : - - - - 21 Doldurulabilir Tip

1

Fiyat sorunuz.



P+/G 1/2"
P-/G 1/2"

Model No: 100 161 []../0397

Arkadan Bağlantı

Bağlantı Tipi No : - - - - 72 IP65, Kuru Tip Doldurulamaz
Bağlantı Tipi No : - - - - 22 Doldurulabilir Tip

1

STATİK BASINÇ MAKS. 100 BAR

80x80 Cl. 10 KAPSÜL DİYAFRAMLI FARK BASINÇ ÖLÇER 0/+300, 0/+600, 0/+1000, 0/+2000 mbar

Gövde: Pirinç
Kapak: Akritik

mbar/psi

IP65

Ex Fiyat Sorunuz

Doğalgaz için



P+/G 1/4"
P-/G 1/4"

* Standart kablo uzunluğu 2 metredir. İlave 1 mt kablo farkı 1,60 €'dir.

1

Model No	Kollektör	Kontak	€
080 162	-	-	54,00
080 162...NA	-	NO	71,00
080 160	Çelik	-	96,00
080 160...NA		NO	113,00
080 161	AISI 316L	-	144,00
080 161...NA		NO	161,00

STATİK BASINÇ MAKS. 250 BAR

Ø100
Ø160

Cl. 1,6
G 1/2"
IP65

FARK BASINÇ ÖLÇER

0/1..1,6..2,5..4..6..10..16..25 bar

bar

Gövde: AISI 316L SS
Kapak: AISI 316L SS
Basınç Elemanı: Paslanmaz
Bağlantı Elemanı: AISI 316L SS
Mekanizma: Paslanmaz



Fiyat Sorunuz

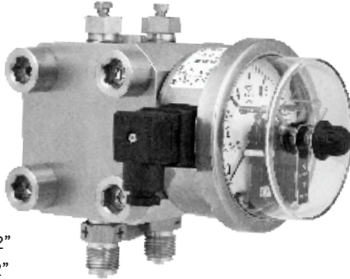

Ø100

Kontaksız,
Tek ve Çift Kontaklı
Modelleri mevcuttur.

Fiyat sorunuz.

P+/G 1/2"
P-/G 1/2"

Model No: 100 161 .../0597

Alttan Bağlantı



Bağlantı Tipi No : - - - - 11 Sıvı Dolgulu Tip
Bağlantı Tipi No : - - - - 21 Doldurulabilir Tip
Bağlantı Tipi No : - - - - 71 Kuru Tip Doldurulamaz



Fiyat Sorunuz



Ø160

Kontaksız,
Tek Kontaklı,
Çift Kontaklı
Modelleri mevcuttur.

Fiyat sorunuz.

P+/G 1/2"
P-/G 1/2"

Model No: 160 161 .../0597

Alttan Bağlantı



Bağlantı Tipi No : - - - - 11 Sıvı Dolgulu Tip
Bağlantı Tipi No : - - - - 21 Doldurulabilir Tip
Bağlantı Tipi No : - - - - 71 Kuru Tip Doldurulamaz

U-MANOMETRE

U

U-MANOMETRE

0/100, 0/120 mbar

mbar

0425

Gövde: Alüminyum



0...100 mbar

€46,10

0...120 mbar

€49,50











Diyafram ayırıcılı sistem siparişleriniz için aşağıdaki bilgileri müşteri temsilcimize iletiniz.

Çalışma Basıncı | Flanş Ölçüleri | Malzeme Detayı | Malzeme Kaplama Detayı* | Akışkan ve Çalışma Sıcaklığı
Diyafram ayırıcılı ürünler, basınç ölçer veya transmitter ile akuple olarak satılmaktadır.

Diğer diyafram modelleri için www.pakkens.com adresini ziyaret ediniz.



  <p>0500 VIDA BAĞLANTILI</p> <p>Komple Paslanmaz AISI 316L SS</p> <p>Bağlantı Tipi No : ----- 01 Alttan Bağlantılı Bağlantı Tipi No : ----- 04 Arkadan Bağlantılı Eksenden Kaçık</p> 	  <p>0520 KADEMELİ FLANŞ BAĞLANTILI</p> <p>Komple Paslanmaz AISI 316L SS</p> <p>Bağlantı Tipi No : ----- 01 Alttan Bağlantılı Bağlantı Tipi No : ----- 04 Arkadan Bağlantılı Eksenden Kaçık</p> 
  <p>0522 DÜZ FLANŞ BAĞLANTILI</p> <p>Komple Paslanmaz AISI 316L SS</p> <p>Bağlantı Tipi No : ----- 01 Alttan Bağlantılı Bağlantı Tipi No : ----- 04 Arkadan Bağlantılı Eksenden Kaçık</p> 	  <p>0530 DÜZ FLANŞ ALTTAN BAĞLANTILI</p> <p>Komple Paslanmaz AISI 316L SS</p> <p>Bağlantı Tipi No : ----- 01 Alttan Bağlantılı Bağlantı Tipi No : ----- 04 Arkadan Bağlantılı Eksenden Kaçık</p> 
  <p>0550 00 GEÇME FLANŞ BAĞLANTILI</p> <p>Komple Paslanmaz AISI 316L SS</p> <p>Bağlantı Tipi No : ----- 01 Alttan Bağlantılı Bağlantı Tipi No : ----- 04 Arkadan Bağlantılı Eksenden Kaçık</p> 	  <p>0550 01 GEÇME FLANŞ BAĞLANTILI</p> <p>Komple Paslanmaz AISI 316L SS</p> <p>Bağlantı Tipi No : ----- 01 Alttan Bağlantılı Bağlantı Tipi No : ----- 04 Arkadan Bağlantılı Eksenden Kaçık</p> 
  <p>0550 03 GEÇME FLANŞ BAĞLANTILI</p> <p>Komple Paslanmaz AISI 316L SS</p> <p>Bağlantı Tipi No : ----- 01 Alttan Bağlantılı Bağlantı Tipi No : ----- 04 Arkadan Bağlantılı Eksenden Kaçık</p> 	  <p>0552 DİYAFRAM FLANŞ BAĞLANTILI</p> <p>Komple Paslanmaz AISI 316L SS</p> <p>Bağlantı Tipi No : ----- 01 Alttan Bağlantılı Bağlantı Tipi No : ----- 04 Arkadan Bağlantılı Eksenden Kaçık</p> 

DİYAFRAM AYIRICILAR

Diyafram ayırıcılı sistem siparişleriniz için aşağıdaki bilgileri müşteri temsilcimize iletiniz.

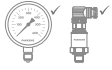
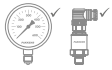
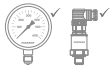
Çalışma Basıncı | Flanş Ölçüleri | Malzeme Detayı | Malzeme Kaplama Detayı* | Akışkan ve Çalışma Sıcaklığı
Diyafram ayırıcılı ürünler, basınç ölçer veya transmitter ile akuple olarak satılmaktadır.Diğer diyafram modelleri için
www.pakkens.com adresini
ziyaret ediniz.Bağlantı Tipi No : ----- 01 Alttan Bağlantılı
Bağlantı Tipi No : ----- 04 Arkadan Bağlantılı Eksenden Kaçık**0564**
SOMUN BAĞLANTILI
KONİK YATAKLAMALI
STERİL TİPKomple Paslanmaz
AISI 316L SSBağlantı Tipi No : ----- 01 Alttan Bağlantılı
Bağlantı Tipi No : ----- 04 Arkadan Bağlantılı Eksenden Kaçık**0564**
KAYNAK BOYUNLU
KONİK YATAKLAMALI
STERİL TİPKomple Paslanmaz
AISI 316L SSBağlantı Tipi No : ----- 01 Alttan Bağlantılı
Bağlantı Tipi No : ----- 04 Arkadan Bağlantılı Eksenden Kaçık**0565**
SOMUN BAĞLANTILI
KONİK YATAKLAMALIKomple Paslanmaz
AISI 316L SSBağlantı Tipi No : ----- 01 Alttan Bağlantılı
Bağlantı Tipi No : ----- 04 Arkadan Bağlantılı Eksenden Kaçık**0565**
KAYNAK BOYUNLU
KONİK YATAKLAMALIKomple Paslanmaz
AISI 316L SSBağlantı Tipi No : ----- 01 Alttan Bağlantılı
Bağlantı Tipi No : ----- 04 Arkadan Bağlantılı Eksenden Kaçık**0566 1**
RAKOR BAĞLANTILI
KONİK YATAKLAMALIKomple Paslanmaz
AISI 316L SSBağlantı Tipi No : ----- 01 Alttan Bağlantılı
Bağlantı Tipi No : ----- 04 Arkadan Bağlantılı Eksenden Kaçık**0566 37**
RAKOR BAĞLANTILI
KAYNAK BOYUNLU
KONİK YATAKLAMALIKomple Paslanmaz
AISI 316L SSBağlantı Tipi No : ----- 01 Alttan Bağlantılı
Bağlantı Tipi No : ----- 04 Arkadan Bağlantılı Eksenden Kaçık**0566 94**
FLANŞ RAKOR BAĞLANTILI
KONİK YATAKLAMALIKomple Paslanmaz
AISI 316L SSBağlantı Tipi No : ----- 01 Alttan Bağlantılı
Bağlantı Tipi No : ----- 04 Arkadan Bağlantılı Eksenden Kaçık**0568**
STERİL TİP
KELEPÇE BAĞLANTILIKomple Paslanmaz
AISI 316L SSBağlantı Tipi No : ----- 01 Alttan Bağlantılı
Bağlantı Tipi No : ----- 04 Arkadan Bağlantılı Eksenden Kaçık**0569 00**
STERİL TİP
YÜKSEK BASINÇ
DİYAFRAM GRUBUKomple Paslanmaz
AISI 316L SSBağlantı Tipi No : ----- 01 Alttan Bağlantılı
Bağlantı Tipi No : ----- 04 Arkadan Bağlantılı Eksenden Kaçık**0569 01**
STERİL TİP
YÜKSEK BASINÇ
DİYAFRAM GRUBUKomple Paslanmaz
AISI 316L SS

* Teflon (PTFE) Kaplama

DİYAFRAM AYIRICILAR

Diyafram ayırıcılı sistem siparişleriniz için aşağıdaki bilgileri müşteri temsilcimize iletiniz.

Çalışma Basıncı | Flanş Ölçüleri | Malzeme Detayı | Malzeme Kaplama Detayı* | Akışkan ve Çalışma Sıcaklığı
Diyafram ayırıcılı ürünler, basınç ölçer veya transmitter ile akuple olarak satılmaktadır.

Diğer diyafram modelleri için
www.pakkens.com adresini
ziyaret ediniz.



0569 02
STERİL TİP
KELEPÇE BAĞLANTILI
YÜKSEK BASINÇ
DİYAFRAM GRUBU
Komple Paslanmaz
AISI 316L SS

Bağlantı Tipi No : - - - - - 01 Alttan Bağlantılı
Bağlantı Tipi No : - - - - - 04 Arkadan Bağlantılı Eksenden Kaçık



0573 0
SOMUN BAĞLANTILI
YÜKSEK BASINÇ
DİYAFRAM GRUBU
Komple Paslanmaz
AISI 316L SS

Bağlantı Tipi No : - - - - - 01 Alttan Bağlantılı
Bağlantı Tipi No : - - - - - 04 Arkadan Bağlantılı Eksenden Kaçık



0573 2
RAKOR BAĞLANTILI,
KONİK YATAKLAMALI
YÜKSEK BASINÇ
DİYAFRAM GRUBU
Komple Paslanmaz
AISI 316L SS

Bağlantı Tipi No : - - - - - 01 Alttan Bağlantılı
Bağlantı Tipi No : - - - - - 04 Arkadan Bağlantılı Eksenden Kaçık

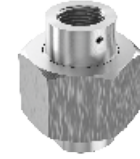

0573 1
SOMUN, RAKOR BAĞLANTILI
YÜKSEK BASINÇ
DİYAFRAM GRUBU
Komple Paslanmaz
AISI 316L SS

Bağlantı Tipi No : - - - - - 01 Alttan Bağlantılı
Bağlantı Tipi No : - - - - - 04 Arkadan Bağlantılı Eksenden Kaçık

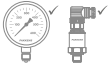

0579
RAKOR BAĞLANTILI
YÜKSEK BASINÇ
DİYAFRAM GRUBU
Komple Paslanmaz
AISI 316L SS

Bağlantı Tipi No : - - - - - 01 Alttan Bağlantılı
Bağlantı Tipi No : - - - - - 04 Arkadan Bağlantılı Eksenden Kaçık



SCHAEFFER TİP

Schaeffer tip siparişleriniz için aşağıdaki bilgileri müşteri temsilcimize iletiniz.

Çalışma Basıncı | Flanş Ölçüleri | Malzeme Kaplama Detayı* | Akışkan ve Çalışma Sıcaklığı

**0504**

0/40...0/400 mbar

0506

0/0,6...0/25 bar

Komple Paslanmaz
316L SS

Vida Bağlantılı

**0524**

0/40...0/400 mbar

0526

0/0,6...0/25 bar

Komple Paslanmaz
316L SS

Flanş Bağlantılı

**0528**

0/40...0/400 mbar

Komple Paslanmaz
316L SS

Flanş Bağlantılı

**0532**

0/0,6...0/25 bar

Komple Paslanmaz
316L SS

Flanş Bağlantılı



* Teflon (PTFE) Kaplama

MASTAR BASINÇ ÖLÇERLER

Ø160	6 1/2"	MANOMETRE	0/0,6..1.1,6..2,5..4..6..10..16..25..40..60..100..160..250..400..600 bar	bar	160 120 01	Gövde: Metal (Beyaz Boyalı)	IP41
	IP41	VAKUMMETRE	-1/0	bar	160 120 01 --/025	Kapak: Metal (Bayonet)	
						Basınç Elemanı: Bakır Alaşım	
						Bağlantı Elemanı: Pirinç	
						Mekanizma : Pirinç	

 <p>Cl. 0,6 €198,00</p> <p>Model No : 160 120 01 Alttan Bağlantılı</p>	 <p>Cl. 0,25 €245,00</p> <p>Model No : 160 120 01 -- /025 Alttan Bağlantılı</p>	 <p>Kalibrasyon TS EN ISO / IEC 17025 AB-0009-K</p> <p>PAKKENS® KALİBRASYON LABORATUVARI</p>
-----------------------------------------------------------------------------------------------------------------------------------------------------------------	--------------------------------------------------------------------------------------------------------------------------------------------------------------------------	----------------------------------------------------------------------------------------------------------------------------------------------------------------------------------------------------

Sipariş verilirken ;

Sıvı veya Gaz ölçüleceği bildirilmelidir. Kadran üzerine “ L (sıvı)” veya “ G (gaz)” harfleri yazılır, buna göre kalibre edilir. Her mastar basınç ölçerle birlikte, **TÜRKAK (TÜRK AKREDİTASYON KURUMU)** tarafından onaylı basınç laboratuvarımız tarafından “Kalibrasyon Sertifikası (e-sertifika)” verilir.

Not :

Mastar Basınç Ölçerler, yılda en az bir kez kalibre edilmelidirler. Sık kullanımlarda bu süre daha kısa tutulmalıdır.

KALİBRASYON TÜRÜ	KLAS*	€
Basınç Ölçer Kalibrasyonu	2,5	15,50
Basınç Ölçer Kalibrasyonu	1,0 - 1,6	18,70
Basınç Ölçer Kalibrasyonu	0,6	25,30
Basınç Ölçer Kalibrasyonu	0,1 - 0,25	49,80
Sıcaklık Ölçer Kalibrasyonu*	2,0	18,70
Sıcaklık Ölçer Kalibrasyonu*	1,0	25,30
Basılı Sertifika Fiyat Farkı	Tüm Klaslar	5,00

*Sıcaklık Ölçerler TÜRKAK akreditasyon kapsamı dışında sertifikalandırılmaktadır.

MANİFOLDLAR

1 YOLLU

1 ADET AÇMA - KAPAMA VANASI
1 ADET TAHLİYE TAPASI

Çalışma Basıncı (Azami)
413 bar (6000 psi) / 38°C
Çalışma Sıcaklığı
-54°C / +210°C

**MP1012**

Paslanmaz
316L SS

Fiyat sorunuz.

1/2" NPT Dişi - 1/2" NPT Dişi

**MP1022**

Paslanmaz
316L SS

Fiyat sorunuz.

1/2" NPT Erkek - 1/2" NPT Dişi

**MP1032**

Paslanmaz
316L SS

Fiyat sorunuz.

1/2" NPT Erkek - 1/2" NPT Erkek

**MP1052**

Paslanmaz
316L SS

Fiyat sorunuz.

1/2" NPT Erkek - 1/2" NPT Dişi

**MP1062**

Paslanmaz
316L SS

Fiyat sorunuz.

1/2" NPT Erkek - 1/2" NPT Dişi



2 YOLLU

1 ADET AÇMA - KAPAMA VANASI
1 ADET TAHLİYE VANASI
1 ADET TAHLİYE TAPASI

Çalışma Basıncı (Azami)
413 bar (6000 psi) / 38°C
Çalışma Sıcaklığı
-54°C / +210°C

**MP2012**

Paslanmaz
316L SS

Fiyat sorunuz.

1/2" NPT Dişi - 1/2" NPT Dişi

**MP2022**

Paslanmaz
316L SS

Fiyat sorunuz.

1/2" NPT Erkek - 1/2" NPT Dişi

**MP2032**

Paslanmaz
316L SS

Fiyat sorunuz.

1/2" NPT Erkek - 1/2" NPT Erkek

**MP2072**

Paslanmaz
316L SS

Fiyat sorunuz.

1/2" NPT Dişi - 1/2" NPT Dişi

**MP2082**

Paslanmaz
316L SS

Fiyat sorunuz.

1/2" NPT Erkek - 1/2" NPT Dişi

**MP2092**

Paslanmaz
316L SS

Fiyat sorunuz.

1/2" NPT Dişi - 1/2" NPT Dişi

**MP2102**

Paslanmaz
316L SS

Fiyat sorunuz.

1/2" NPT Dişi - 1/2" NPT Dişi

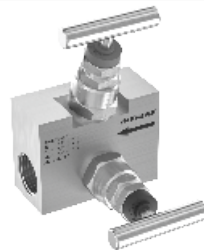
**MP2112**

Paslanmaz
316L SS

Fiyat sorunuz.

1/2" NPT Dişi - 1/2" NPT Dişi



MANİFOLDLAR

3 YOLLU

2 ADET AÇMA - KAPAMA VANASI
1 ADET BİRLEŞTİRME VANASI
2 ADET TAHLİYE TAPASI

Çalışma Basıncı (Azami)
413 bar (6000 psi) / 38°C
Çalışma Sıcaklığı
-54°C / +210°C



MP3092

Paslanmaz
316L SS

Fiyat sorunuz.

1/2" NPT Dişi - 1/2" NPT Dişi



MP3125

Paslanmaz
316L SS

Fiyat sorunuz.

1/2" NPT Dişi - Flanş



MP3135

Paslanmaz
316L SS

Fiyat sorunuz.

1/2" NPT Dişi - Flanş

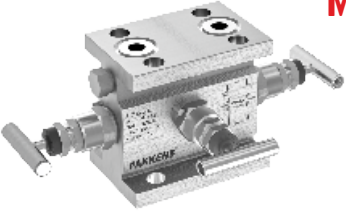

MP3146

Paslanmaz
316L SS

Fiyat sorunuz.

Flanş - Flanş



5 YOLLU

2 ADET AÇMA - KAPAMA VANASI
2 ADET TAHLİYE VANASI
1 ADET BİRLEŞTİRME VANASI
1 ADET TAHLİYE TAPASI

Çalışma Basıncı (Azami)
413 bar (6000 psi) / 38°C
Çalışma Sıcaklığı
-54°C / +210°C

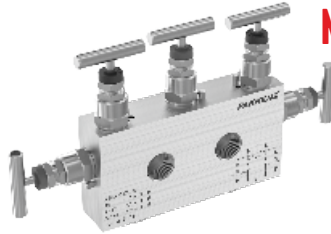

MP5092

Paslanmaz
316L SS

Fiyat sorunuz.

1/2" NPT Dişi - 1/2" NPT Dişi

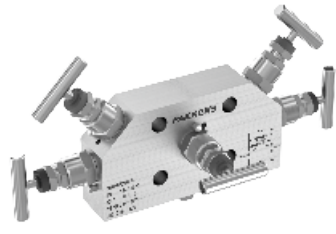

MP5125

Paslanmaz
316L SS

Fiyat sorunuz.

1/2" NPT Dişi - Flanş



MP5135

Paslanmaz
316L SS

Fiyat sorunuz.

1/2" NPT Dişi - Flanş



MP5146

Paslanmaz
316L SS

Fiyat sorunuz.

Flanş - Flanş



AKSESUARLAR VE KORUYUCU EKİPMANLAR

TSEK

MANOMETRE MUSLUĞU

3 Yollu
Manometre Musluğu

G1/2" Dişi - G1/2" Dişi

€10,75

G1/2" Dişi - G1/4" Dişi

€10,75

Pirinç Nikel Kaplamalı

Model No: 91040040400

G1/2" - G1/2"

PN6



Model No: 91040040200

G1/2" - G1/4"

PN6

3 Yollu
Manometre Musluğu

Pirinç - G1/2" - G1/2"

€21,90

Paslanmaz - G1/2" - G1/2"

€48,00

Model No: 91042250400

Pirinç

PN64

5 Ad.

Model No: 91042500000

Paslanmaz

PN64

1 Ad.

2 Yollu
Manometre Musluğu

Pirinç - 1/4" BSPT - G1/4"

€12,45

Paslanmaz - 1/4" BSPT - G1/4"

€35,30

Model No: 91043111100

Pirinç

PN250

5 Ad.

Model No: 91043311100

Paslanmaz

PN250

1 Ad.



Titreşim Kesici

Pirinç - G1/2" - G1/2"

€10,20

Paslanmaz - G1/2" - G1/2"

€15,35

Model No: 91045040401

Pirinç

PN250

5 Ad.

Model No: 91045040407

Paslanmaz

PN400

1 Ad.



Soğutma Kulesi

Pirinç - G1/2" - G1/2"

€10,50

Paslanmaz - G1/2" - G1/2"

€21,80

Model No: 1051040401

Pirinç

PN600

5 Ad.

Model No: 1051040402

Paslanmaz

PN600

1 Ad.



Stoper

Pirinç - 1/2" NPT - G1/4"

€2,10

Model No: 91101000000

25



Yıkama Flaşı

Fiyat sorunuz.

Düz tip flaşlı
diyafram ayırıcılı
sistemlerde kullanılır.

Model No: 0522



Adaptörler

Fiyat sorunuz.

Model No: 1050



AKIŞ KIRICI SIFONLAR

U Tipi
Akış Kırıcı Sifon

Ürün Kodu	Malzeme	Bağlantı	€
1046040400	Çelik Ø20 mm	G1/2" Rakor G1/2" Somun	9,75
1046200400	Paslanmaz Ø20 mm	G1/2" Rakor G1/2" Somun	26,40
1046900404	Çelik Ø20 mm	G1/2" Rakor G1/2" Rakor	9,00
1046040407	Paslanmaz Ø20 mm	G1/2" Rakor G1/2" Rakor	22,00

PN100

Çelik: 10 Ad.
Paslanmaz: 1 Ad.90° - O Tipi
Akış Kırıcı Sifon

Ürün Kodu	Malzeme	Bağlantı	€
1046701100	Çelik Ø20 mm	G1/2" Rakor G1/2" Somun	9,75
1046241100	Paslanmaz Ø20 mm	G1/2" Rakor G1/2" Somun	26,40
1046791100	Çelik Ø20 mm	G1/2" Rakor G1/2" Rakor	9,00
1046291100	Paslanmaz Ø20 mm	G1/2" Rakor G1/2" Rakor	22,00

PN100

Çelik: 10 Ad.
Paslanmaz: 1 Ad.180° - O Tipi
Akış Kırıcı Sifon

Ürün Kodu	Malzeme	Bağlantı	€
1047040400	Çelik Ø20 mm	G1/2" Rakor G1/2" Somun	10,10
1047200400	Paslanmaz Ø20 mm	G1/2" Rakor G1/2" Somun	28,70
1047900404	Çelik Ø20 mm	G1/2" Rakor G1/2" Rakor	10,10
1047040407	Paslanmaz Ø20 mm	G1/2" Rakor G1/2" Rakor	25,60

PN100

Çelik: 10 Ad.
Paslanmaz: 1 Ad.



SICAKLIK



SICAKLIK

ÖLÇERLER

Ø63	Cl. 2,0	TERMOMETRE	-30...+60*, 0...+120*, 160*, 200*, 250, 300, 350, 400, 500 °C	°C	063 402	Gövde: AISI 430 SS Kapak: AISI 430 SS Termovil: AISI 316L SS 5 cm termoviller piring üretilir.	
	G 1/2"		* Sadece 5 cm. için mevcut sıcaklık skalaları	°C			
	IP51						



Dalma Boyu		€
* 5 cm	25 ad.	3,95
10 cm	2 ad.	6,15
15 cm	2 ad.	7,70
20 cm	1 ad.	8,90
25 cm	1 ad.	9,90
30 cm	1 ad.	10,80
40 cm	1 ad.	13,50
50 cm	1 ad.	16,40

Model No: **063 402**
Arkadan Bağlantılı

Ø100	Cl. 2,0	TERMOMETRE	-30...+60, 0...+120, 160, 200, 250, 300, 350, 400, 500 °C	°C	100 401	Gövde: AISI 430 SS Kapak: AISI 430 SS Termovil: AISI 316L SS 5 cm termoviller piring üretilir.	
	G 1/2"		-30...+60*, 0...+120*, 160*, 200*, 250, 300, 350, 400, 500 °C	°C		100 402	
	IP51		* Sadece 5 cm. için mevcut sıcaklık skalaları				



Dalma Boyu		€
10 cm	4 ad.	10,30
15 cm	2 ad.	11,55
20 cm	2 ad.	12,95
25 cm	1 ad.	14,15
30 cm	1 ad.	15,40
40 cm	1 ad.	18,00
50 cm	1 ad.	20,75
70 cm	1 ad.	26,15
100 cm	1 ad.	34,35

Gövde: Metal (Siyah Boyalı)
Kapak: Metal (Bayonet)

Model No: **100 401**
Alttan Bağlantılı



Dalma Boyu		€
5 cm	6 ad.	4,95
10 cm	4 ad.	7,45
15 cm	2 ad.	8,95
20 cm	2 ad.	10,15
25 cm	2 ad.	11,15
30 cm	1 ad.	12,15
40 cm	1 ad.	14,80
50 cm	1 ad.	18,15
70 cm	1 ad.	23,45
100 cm	1 ad.	31,90

Model No: **100 402**
Arkadan Bağlantılı

Ø160	Cl. 2,0	TERMOMETRE	-30...+60, 0...+120, 160, 200, 250, 300, 350, 400, 500 °C	°C	160 401	Gövde: Metal (Siyah Boyalı) Kapak: Metal, Bayonet Termovil: AISI 316L SS	
	G 1/2"		-30...+60, 0...+120, 160, 200, 250, 300, 350, 400, 500 °C	°C		160 402	
	IP51						



Dalma Boyu		€
10 cm	1 ad.	23,30
15 cm	1 ad.	24,90
20 cm	1 ad.	26,40
25 cm	1 ad.	27,70
30 cm	1 ad.	29,00
40 cm	1 ad.	31,30
50 cm	1 ad.	34,50
70 cm	1 ad.	40,20
100 cm	1 ad.	48,40

Model No: **160 401**
Alttan Bağlantılı



Dalma Boyu		€
10 cm	1 ad.	20,40
15 cm	1 ad.	21,80
20 cm	1 ad.	22,60
25 cm	1 ad.	23,80
30 cm	1 ad.	25,20
40 cm	1 ad.	27,80
50 cm	1 ad.	30,60
70 cm	1 ad.	36,00
100 cm	1 ad.	43,00

Model No: **160 402**
Arkadan Bağlantılı

KOMPLE PASLANMAZ

Ø100	Cl. 2,0	TERMOMETRE	-30...+60, 0...+120, 160, 200, 250, 300, 350, 400, 500 °C Sıkma yüzüklü ürünler için fiyat sorunuz.	°C	100 411	Gövde: AISI 304 SS Kapak: AISI 304 SS Termovil: AISI 316L SS	
	G 1/2"				100 412		
	IP51						



Model No: **100 411**
Alttan Bağlantılı



Dalma Boyu	€
10 cm	19,60
15 cm	21,50
20 cm	23,30
25 cm	25,60
30 cm	27,60
40 cm	31,30
50 cm	34,80
70 cm	42,90
100 cm	54,60



Model No: **100 412**
Arkadan Bağlantılı



Dalma Boyu	€
10 cm	19,40
15 cm	21,40
20 cm	22,90
25 cm	24,80
30 cm	26,30
40 cm	30,10
50 cm	34,10
70 cm	42,20
100 cm	53,60

Ø160	Cl. 2,0	TERMOMETRE	-30...+60, 0...+120, 160, 200, 250, 300, 350, 400, 500 °C Sıkma yüzüklü ürünler için fiyat sorunuz.	°C	160 411	Gövde: AISI 304 SS Kapak: AISI 304 SS Termovil: AISI 316L SS	
	G 1/2"				160 412		
	IP51						



Model No: **160 411**
Alttan Bağlantılı



Dalma Boyu	€
10 cm	34,00
15 cm	36,00
20 cm	37,00
25 cm	39,00
30 cm	42,00
40 cm	47,00
50 cm	52,00
70 cm	58,00
100 cm	70,00



Model No: **160 412**
Arkadan Bağlantılı



Dalma Boyu	€
10 cm	33,00
15 cm	35,00
20 cm	36,00
25 cm	38,00
30 cm	40,00
40 cm	44,00
50 cm	48,00
70 cm	57,00
100 cm	67,00

KOMPLE PASLANMAZ, SIZDIRMAZ TİP

Ø100	Cl. 2,0	Cl. 1,0	TERMOMETRE	-30...+60, 0...+120, 160, 200, 250, 300, 350, 400, 500 °C Sıkma yüzüklü ürünler için fiyat sorunuz.	°C	100 451	Gövde: AISI 304 SS Kapak: AISI 304 SS Termovül: AISI 316L SS	
	G 1/2"					100 851		
	IP65					100 452 100 852		

Ex Fiyat Sorunuz



Dalma Boyu	Cl. 2,0	Cl. 1,0
10 cm	27,50	32,50
15 cm	29,80	34,80
20 cm	31,50	36,50
25 cm	33,00	38,00
30 cm	35,00	40,00
40 cm	38,00	43,00
50 cm	43,00	48,00
70 cm	51,00	56,00
100 cm	62,00	67,00

4 Cl. 2,0
8 Cl. 1,0

Model No: **100 451**
Alttan Bağlantılı

1

Ex Fiyat Sorunuz



Dalma Boyu	Cl. 2,0	Cl. 1,0
10 cm	25,50	30,50
15 cm	27,50	32,50
20 cm	29,40	34,40
25 cm	31,30	36,30
30 cm	33,20	38,20
40 cm	37,00	42,00
50 cm	41,00	46,00
70 cm	48,50	53,50
100 cm	60,00	65,00

4 Cl. 2,0
8 Cl. 1,0

Model No: **100 452**
Arkadan Bağlantılı

1

Ø160	Cl. 2,0	Cl. 1,0	TERMOMETRE	-30...+60, 0...+120, 160, 200, 250, 300, 350, 400, 500 °C Sıkma yüzüklü ürünler için fiyat sorunuz.	°C	160 451	Gövde: AISI 304 SS Kapak: AISI 304 SS Termovül: AISI 316L SS	
	G 1/2"					160 851		
	IP65					160 452 160 852		

Ex Fiyat Sorunuz



Dalma Boyu	Cl. 2,0	Cl. 1,0
10 cm	34,70	39,70
15 cm	36,70	41,70
20 cm	38,70	43,70
25 cm	40,60	45,60
30 cm	42,70	47,70
40 cm	46,60	51,60
50 cm	50,60	55,60
70 cm	58,70	63,70
100 cm	70,70	75,70

4 Cl. 2,0
8 Cl. 1,0

Model No: **160 451**
Alttan Bağlantılı

1

Ex Fiyat Sorunuz



Dalma Boyu	Cl. 2,0	Cl. 1,0
10 cm	32,70	37,70
15 cm	34,70	39,70
20 cm	36,70	41,70
25 cm	38,70	43,70
30 cm	40,70	45,70
40 cm	44,70	49,70
50 cm	48,70	53,70
70 cm	56,70	61,70
100 cm	68,70	73,70

4 Cl. 2,0
8 Cl. 1,0

Model No: **160 452**
Arkadan Bağlantılı

1

Ø100 Ø160	Cl. 2,0	Cl. 1,0	TERMOMETRE	-30...+60, 0...+120, 160, 200, 250, 300, 350, 400, 500 °C Stem çapı: 9 mm (Opsiyon: 6, 8, 10 mm) Konum ayarlı ürünler sıkma yüzüklüdür.	°C	100 453	Gövde: AISI 304 SS Kapak: AISI 304 SS Stem: AISI 316L SS	
	G 1/2"					100 853		
	IP65					160 453 160 853		

Ex Fiyat Sorunuz



Dalma Boyu	Cl. 2,0	Cl. 1,0
10 cm	61,50	66,50
15 cm	63,50	68,50
20 cm	65,50	70,50
25 cm	67,00	72,00
30 cm	69,00	74,00
40 cm	73,00	78,00
50 cm	76,50	81,50
70 cm	84,00	89,00
100 cm	95,50	100,50

4 Cl. 2,0
8 Cl. 1,0

Model No: **100 453**
Konum Ayarlı

1

Ex Fiyat Sorunuz



Dalma Boyu	Cl. 2,0	Cl. 1,0
10 cm	68,50	73,50
15 cm	70,50	75,50
20 cm	72,00	77,00
25 cm	74,00	79,00
30 cm	76,00	81,00
40 cm	80,00	85,00
50 cm	83,50	88,50
70 cm	91,50	96,50
100 cm	103,00	108,00



4 Cl. 2,0
8 Cl. 1,0



Model No: **160 453**
Konum Ayarlı

1



KOMPLE PASLANMAZ, SIVI DOLGULU



Ø100	Cl. 2,0	Cl. 1,0	TERMOMETRE	-30...+60, 0...+120, 160, 200, 250, 300 °C Sıkma yüzüklü ürünler için fiyat sorunuz.	°C	100 461	Gövde: AISI 304 SS Kapak: AISI 304 SS Termovül: AISI 316L SS	
	G 1/2"					100 861		
	IP65					100 462 100 862		

 Fiyat Sorunuz		Dalma Boyu	Cl. 2,0	Cl. 1,0
			€	€
		10 cm	38,00	43,00
		15 cm	40,00	45,00
		20 cm	41,50	46,50
		25 cm	43,50	48,50
		30 cm	45,50	50,50
		40 cm	49,00	54,00
		50 cm	53,00	58,00
		70 cm	60,50	65,50
100 cm	71,50	76,50		
4 Cl. 2,0 8 Cl. 1,0	Model No: 100 461	1	Alttan Bağlantılı	



 Fiyat Sorunuz		Dalma Boyu	Cl. 2,0	Cl. 1,0
			€	€
		10 cm	36,00	41,00
		15 cm	38,00	43,00
		20 cm	40,00	45,00
		25 cm	41,50	46,50
		30 cm	43,50	48,50
		40 cm	47,50	52,50
		50 cm	51,00	56,00
		70 cm	58,00	63,00
100 cm	69,50	74,50		
4 Cl. 2,0 8 Cl. 1,0	Model No: 100 462	1	Arkadan Bağlantılı	



Ø160	Cl. 2,0	Cl. 1,0	TERMOMETRE	-30...+60, 0...+120, 160, 200, 250, 300 °C Sıkma yüzüklü ürünler için fiyat sorunuz.	°C	160 461	Gövde: AISI 304 SS Kapak: AISI 304 SS Termovül: AISI 316L SS	
	G 1/2"					160 861		
	IP65					160 462 160 862		

 Fiyat Sorunuz		Dalma Boyu	Cl. 2,0	Cl. 1,0
			€	€
		10 cm	71,00	76,00
		15 cm	73,00	78,00
		20 cm	75,00	80,00
		25 cm	77,00	82,00
		30 cm	79,00	84,00
		40 cm	82,00	87,00
		50 cm	86,00	91,00
		70 cm	94,00	99,00
100 cm	105,00	110,00		
4 Cl. 2,0 8 Cl. 1,0	Model No: 160 461	1	Alttan Bağlantılı	

 Fiyat Sorunuz		Dalma Boyu	Cl. 2,0	Cl. 1,0
			€	€
		10 cm	72,00	77,00
		15 cm	74,00	79,00
		20 cm	76,00	81,00
		25 cm	78,00	83,00
		30 cm	80,00	85,00
		40 cm	84,00	89,00
		50 cm	88,00	93,00
		70 cm	96,00	101,00
100 cm	108,00	113,00		
4 Cl. 2,0 8 Cl. 1,0	Model No: 160 462	1	Arkadan Bağlantılı	

Ø100 Ø160	Cl. 2,0	Cl. 1,0	TERMOMETRE	-30...+60, 0...+120, 160, 200, 250, 300 °C Stem çapı: 9 mm [Opsiyon: 6, 8, 10 mm] Konum ayarlı ürünler sıkma yüzüklüdür.	°C	100 463	Gövde: AISI 304 SS Kapak: AISI 304 SS Stem: AISI 316L SS	
	G 1/2"					100 863		
	IP65					160 463 160 863		

 Fiyat Sorunuz		Dalma Boyu	Cl. 2,0	Cl. 1,0
			€	€
		10 cm	75,00	80,00
		15 cm	77,00	82,00
		20 cm	79,00	84,00
		25 cm	81,00	86,00
		30 cm	83,00	88,00
		40 cm	87,00	92,00
		50 cm	91,00	96,00
		70 cm	99,00	104,00
100 cm	111,00	116,00		
4 Cl. 2,0 8 Cl. 1,0	Model No: 100 463	1	Konum Ayarlı	

 Fiyat Sorunuz		Dalma Boyu	Cl. 2,0	Cl. 1,0
			€	€
		10 cm	110,00	115,00
		15 cm	112,00	117,00
		20 cm	114,00	119,00
		25 cm	116,00	121,00
		30 cm	118,00	123,00
		40 cm	122,00	127,00
		50 cm	126,00	131,00
		70 cm	133,00	138,00
100 cm	145,00	150,00		
4 Cl. 2,0 8 Cl. 1,0	Model No: 160 463	1	Konum Ayarlı	

Ø100
Ø160

Cl. 2,0

G 1/2" TERMOMETRE

IP51

-40...+40, 0...+120, 160, 200, 250, 300, 350 °C

°C

100 511

100 512

160 511

160 512

Gövde: AISI 304 SS

Kapak: AISI 304 SS

Bulb: AISI 316L SS



Model No.	Kapiler	€
100 511	3 mt.	79,00
100 512		
100 511	5 mt.	98,00
100 512		

Model No: **100 511**

Alttan Çıkış - Arkadan Flanşlı

Model No: **100 512**

Arkadan Çıkışlı - Önden Flanşlı



Model No.	Kapiler	€
160 511	3 mt.	92,00
160 512		
160 511	5 mt.	112,00
160 512		

Model No: **160 511**

Alttan Çıkış - Arkadan Flanşlı

Model No: **160 512**

Arkadan Çıkışlı - Önden Flanşlı



HASSAS

Ø100
Ø160

Cl. 1,0

G 1/2"

TERMOMETRE

IP51

-40...+60, 0...+120, 160, 200, 250, 300, 350, 400, 500 °C

°C

100 611

100 612

160 611

160 612

Gövde: AISI 304 SS

Kapak: AISI 304 SS

Bulb: AISI 316L SS



Model No.	Kapiler	€
100 611	3 mt.	132,00
100 612		
100 611	5 mt.	158,00
100 612		

Model No: 100 611

Alttan Çıkış - Arkadan Flanşlı

Model No: 100 612

Arkadan Çıkışlı - Önden Flanşlı



Model No.	Kapiler	€
160 611	3 mt.	144,00
160 612		
160 611	5 mt.	170,00
160 612		

Model No: 160 611

Alttan Çıkış - Arkadan Flanşlı

Model No: 160 612

Arkadan Çıkışlı - Önden Flanşlı



HASSAS, SIZDIRMAZ

Ø100
Ø160

Cl. 1,0

G 1/2"

TERMOMETRE

IP65

-40...+60, 0...+120, 160, 200, 250, 300, 350, 400, 500 °C

°C

100 651

100 652

160 651

160 652

Gövde: AISI 304 SS

Kapak: AISI 304 SS

Bulb: AISI 316L SS



Fiyat Sorunuz

Model No.	Kapiler	€
100 651	3 mt.	151,00
100 652		
100 651	5 mt.	178,00
100 652		

Model No: 100 651

Alttan Çıkış - Arkadan Flanşlı

Model No: 100 652

Arkadan Çıkışlı - Önden Flanşlı



Fiyat Sorunuz

Model No.	Kapiler	€
160 651	3 mt.	163,00
160 652		
160 651	5 mt.	190,00
160 652		

Model No: 160 651

Alttan Çıkış - Arkadan Flanşlı

Model No: 160 652

Arkadan Çıkışlı - Önden Flanşlı



HASSAS, DOLGULU

Ø100
Ø160

Cl. 1,0

G 1/2"

TERMOMETRE

IP65

-40...+60, 0...+120, 160, 200, 250, 300, 350, 400, 500 °C

°C

100 661

100 662

160 661

160 662

Gövde: AISI 304 SS

Kapak: AISI 304 SS

Bulb: AISI 316L SS



Fiyat Sorunuz

Model No.	Kapiler	€
100 661	3 mt.	162,00
100 662		
100 661	5 mt.	188,00
100 662		

Model No: 100 661

Alttan Çıkış - Arkadan Flanşlı

Model No: 100 662

Arkadan Çıkışlı - Önden Flanşlı



Fiyat Sorunuz

Model No.	Kapiler	€
160 661	3 mt.	200,00
160 662		
160 661	5 mt.	227,00
160 662		

Model No: 160 661

Alttan Çıkış - Arkadan Flanşlı

Model No: 160 662

Arkadan Çıkışlı - Önden Flanşlı



Ø60	Cl. 2,0	-30...+60, 0...+120, 160, 200 °C	Kapiler borusu PVC kaplı	°C	060 522	Gövde: Metal (Siyah Boyalı) Kapak: AISI 430 SS Termovil: Pirinç				
	G 3/8" TERMOMETRE							0...+250, 300, 350 °C	Kapiler borusu paslanmaz örgülü	°C
	IP51									

Microtac®



Kontakt	Kapiler	€
TK (NC/NO)	2 mt. PVC kaplı	47,40
	Kapiler ilavesi (1 mt için)	1,80

Model No: **060 522**
Arkadan Bağlantılı Pano Tip



TK: NO - NC | ÇK: NCNO - NONC - NONO-NCNC

STANDART, KOMPLE PASLANMAZ

Ø100 Ø160	Cl. 2,0	-40...+40, 0...+120, 160, 200, 250, 300, 350 °C	°C	<input type="checkbox"/>	100 511 <input type="checkbox"/>	Gövde: AISI 304 SS Kapak: AISI 304 SS Bulb: AISI 316L SS			
	G 1/2" TERMOMETRE							<input type="checkbox"/>	<input type="checkbox"/>
	IP51							<input type="checkbox"/>	<input type="checkbox"/>



Model No.	Kapiler	Kontakt	€
100 511	3 mt.	TK	142,00
100 512		ÇK	162,00
100 511	5 mt.	TK	161,00
100 512		ÇK	181,00

Model No: **100 511**
Alttan Çıkış - Arkadan Flanşlı

Model No: **100 512**
Arkadan Çıkışlı - Önden Flanşlı

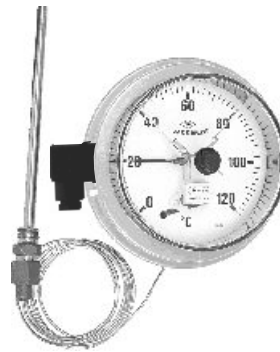

Model No.	Kapiler	Kontakt	€
160 511	3 mt.	TK	155,00
160 512		ÇK	175,00
160 511	5 mt.	TK	174,00
160 512		ÇK	194,00

Model No: **160 511**
Alttan Çıkış - Arkadan Flanşlı

Model No: **160 512**
Arkadan Çıkışlı - Önden Flanşlı



HASSAS

TK: NO - NC | ÇK: NCNO - NONC - NONO-NCNC

Ø100
Ø160Cl. 1,0
G 1/2"
IP51

TERMOMETRE

-40...+60, 0...+120, 160, 200, 250, 300, 350, 400, 500 °C

°C

100 611
100 612
160 611
160 612 Gövde: AISI 304 SS
Kapak: AISI 304 SS
Bulb: AISI 316L SS

Model No.	Kapiler	Kontakt	€
100 611	3 mt.	TK	194,00
100 612		ÇK	215,00
100 611	5 mt.	TK	221,00
100 612		ÇK	241,00

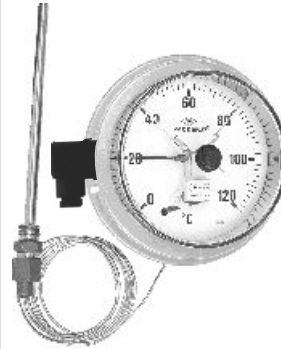
Model No: 100 611
Alttan Çıkış - Arkadan FlanşlıModel No: 100 612
Arkadan Çıkışlı - Önden Flanşlı

Model No.	Kapiler	Kontakt	€
160 611	3 mt.	TK	206,00
160 612		ÇK	227,00
160 611	5 mt.	TK	233,00
160 612		ÇK	253,00

Model No: 160 611
Alttan Çıkış - Arkadan FlanşlıModel No: 160 612
Arkadan Çıkışlı - Önden Flanşlı

HASSAS, SIZDIRMAZ

TK: NO - NC | ÇK: NCNO - NONC - NONO-NCNC

Ø100
Ø160Cl. 1,0
G 1/2"
IP65

TERMOMETRE

-40...+60, 0...+120, 160, 200, 250, 300, 350, 400, 500 °C

°C

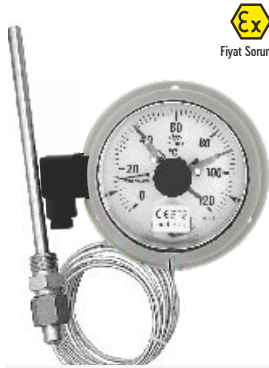
100 651
100 652
160 651
160 651 Gövde: AISI 304 SS
Kapak: AISI 304 SS
Bulb: AISI 316L SS

Fiyat Sorunuz

Model No.	Kapiler	Kontakt	€
100 651	3 mt.	TK	214,00
100 652		ÇK	234,00
100 651	5 mt.	TK	240,00
100 652		ÇK	260,00

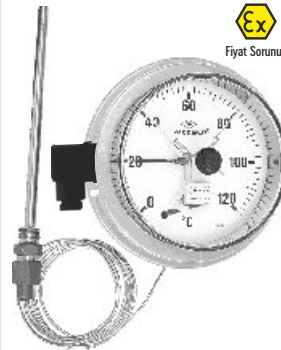
Model No: 100 651
Alttan Çıkış - Arkadan FlanşlıModel No: 100 652
Arkadan Çıkışlı - Önden Flanşlı

Fiyat Sorunuz

Model No.	Kapiler	Kontakt	€
160 651	3 mt.	TK	226,00
160 652		ÇK	246,00
160 651	5 mt.	TK	252,00
160 652		ÇK	272,00

Model No: 160 651
Alttan Çıkış - Arkadan FlanşlıModel No: 160 652
Arkadan Çıkışlı - Önden Flanşlı

HASSAS, DOLGULU

TK: NO - NC | ÇK: NCNO - NONC - NONO-NCNC

Ø100
Ø160Cl. 1,0
G 1/2"
IP65

TERMOMETRE

-40...+60, 0...+120, 160, 200, 250, 300, 350, 400, 500 °C

°C

100 661
100 662
160 661
160 661 Gövde: AISI 304 SS
Kapak: AISI 304 SS
Bulb: AISI 316L SS

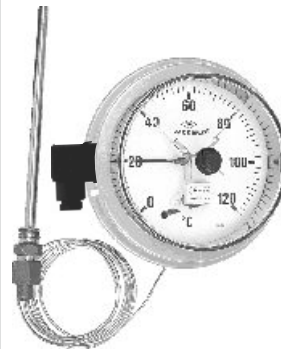

Model No.	Kapiler	Kontakt	€
100 661	3 mt.	TK	224,00
100 662		ÇK	245,00
100 661	5 mt.	TK	251,00
100 662		ÇK	271,00

Model No: 100 661
Alttan Çıkış - Arkadan FlanşlıModel No: 100 662
Arkadan Çıkışlı - Önden Flanşlı

Model No.	Kapiler	Kontakt	€
160 661	3 mt.	TK	263,00
160 662		ÇK	283,00
160 661	5 mt.	TK	289,00
160 662		ÇK	310,00

Model No: 160 661
Alttan Çıkış - Arkadan FlanşlıModel No: 160 662
Arkadan Çıkışlı - Önden Flanşlı

GENEL AMAÇLI

Ø40 Ø50	Cl. 2,0	TERMOMETRE	0...+120 °C	°C	040 502	Gövde: Plastik Kapak: Akrilik Bulb: Bakır	 
	IP41				050 502		



Kapiler		€
1 mt	20 ad.	4,50
3 mt	10 ad.	5,65

Model No: **040 502**
Arkadan Bağlantılı Pano Tip



Kapiler		€
1 mt	20 ad.	4,05
3 mt	10 ad.	5,20

Model No: **050 502**
Arkadan Bağlantılı Pano Tip

Ø60	Cl. 2,0	TERMOMETRE	-40...+40, 0...+120, 160, 200 °C	Kapiler borusu PVC kaplı	°C	060 502	Gövde: AISI 430 SS Kapak: AISI 430 SS Bulb: Bakır	 
	IP41		0...+250, 300, 350 °C	Kapiler borusu paslanmaz örgülü	°C			



Kapiler	€
1 mt. PVC kaplı	6,70
1 mt. Paslanmaz örgülü	7,75
2 mt. PVC kaplı	7,40
2 mt. Paslanmaz örgülü	8,95

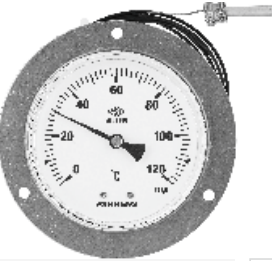

Model No: **060 502**
Arkadan Bağlantılı Pano Tip

Ø100	Cl. 2,0	TERMOMETRE	-40...+40, 0...+120, 160, 200 °C	Kapiler borusu PVC kaplı	°C	100 532	Gövde: AISI 304 SS Kapak: Akrilik Bulb: Bakır	 
	G 1/4"		IP41	0...+250, 300, 350 °C	Kapiler borusu paslanmaz örgülü			



Kapiler	€
2 mt. PVC kaplı	19,05
Kapiler İlavesi (1 mt. için)	0,70
2 mt. Paslanmaz örgülü	22,20
Kapiler İlavesi (1 mt. için)	1,20

Model No: **100 532**
Arkadan Bağlantılı - Önden Flaşlı

58x25 62x12	Cl. 2,0	TERMOMETRE	-40...+40, 0...+120 °C	°C	058 502	Gövde: Plastik Kapak: Akrilik Bulb: Bakır	 
	IP41				062 502		



Kapiler	€
1 mt	5,20
3 mt	6,60

Model No: **058 502**
Arkadan Bağlantılı Pano Tip



Kapiler	€
1 mt	4,50
3 mt	5,90

Model No: **062 502**
Arkadan Bağlantılı Pano Tip

KOMBİNE ÖLÇERLER

Ø40 Ø50	6 1/4"	KOMBİNE ÖLÇER	0...+120 °C	0/4, 6 bar	°C / bar	040 702	Gövde: Plastik Kapak: Akrilik Bağlantı Elemanı: Pirinç Basınç Elemanı: Bakır Alaşımı Mekanizma: Pirinç Bulb: Bakır	TSC PC
	IP41		0...+120 °C	0/4, 6 bar	°C / bar	050 702		



Kapiler	€
1 mt.	11,45

Model No: 040 702

Arkadan Bağlantılı Pano Tip



Kapiler	€
1 mt.	12,95

Model No: 050 702

Arkadan Bağlantılı Pano Tip



Ø100	6 1/2"	KOMBİNE ÖLÇER	0...+120 °C	0/4, 6, 10,16, 25 bar	°C / bar	100 700 01	Gövde: Metal (Siyah Boyalı) Kapak: Akrilik Bağlantı Elemanı: Pirinç Basınç Elemanı: Bakır Alaşımı Mekanizma: Pirinç Sıcaklık Elemanı Kılıfı: Pirinç	TSC PC
	IP41							



€13,30

Model No: 100 700 01

Alttan Bağlantılı



REGÜLATÖR

KATI YAKIT TERMOSTATİK REGÜLATÖRÜ	30/90°C	079 000 10	Bağlantı Dişi : G3/4" Gövde (Proses Bağlantısı): Pirinç Ayar Kapağı: Plastik Çalışma Pozisyonu: Dikey, Yatay, Dikey Yan.	TSC PC
--------------------------------------	---------	------------	--------------------------------------------------------------------------------------------------------------------------------------	-----------



€13,65

STANDART TERMOVİLLER

TER

G 1/2" TERMOVİL

TER

Malzeme: AISI 316L SS
Termovil Çapı: Ø12 mm
Termovil İç Delik Çapı: Ø10 mm

Ürün Kodu	Dalma Boyu (mm)	€
0510 (Pirinç)	50	1,85
0520	50	4,20
1020	100	4,60
1520	150	4,85
2020	200	5,40
2520	250	6,20
3020	300	7,35
4020	400	9,45
5020	500	11,60
7020	700	15,90
9920	1000	20,90

Model No: TER
Vida Bağlantılı

ÖZEL TERMOVİLLER

TER

TERMOVİL

Özel termovil talepleriniz için, talep ettiğiniz termovil ölçülerini içeren teknik resim ile satış departmanımızla iletişime geçebilirsiniz.

Malzeme: AISI 316L SS



Diş Bağlantılı



Bar Stock, Kaynaklı Tip



Flanş Bağlantılı

Fiyatlarımıza K.D.V. dahil değildir.

Ödeme vadesi 60 (altmış) gündür.

Bu fiyat listesi en güncel bilgileri sunmaktadır.



PAKKENS mamullerin ve fiyatların üzerinde önceden bildirmeden her türlü değişiklik yapma hakkını saklı tutar.



PAKKENS®

PAKKENS A.Ş.

Organize Sanayi Bölgesi
Sarı Cadde No: 20 Nilüfer
16159 Bursa / Türkiye

 www.pakkens.com
 +90 224 6000 200
 +90 224 6000 230



Where Pressure Matters...™